

enbio.

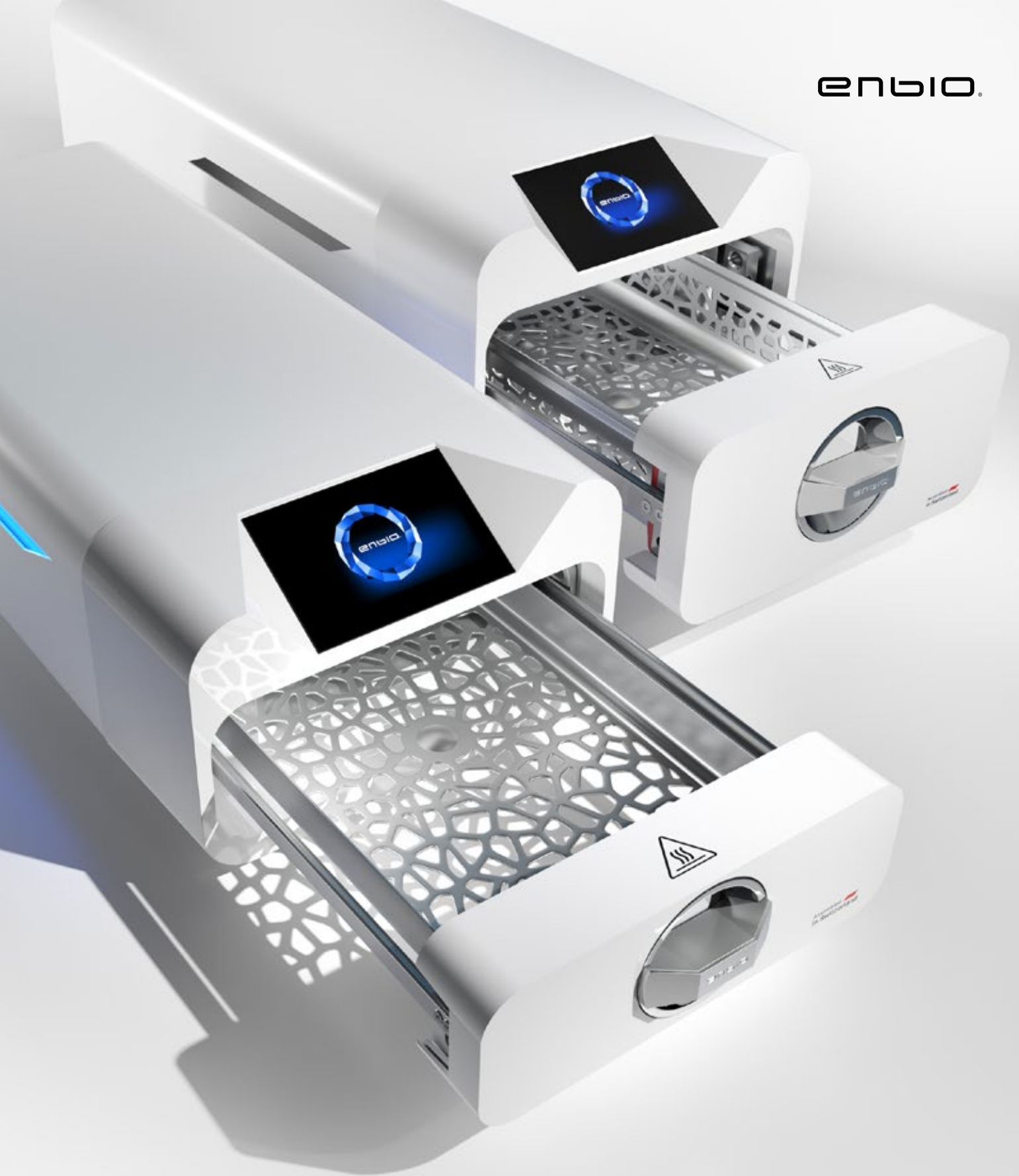

2022.05.12 The latest version of the manual is available at www.enbio.com

Enbio S / Enbio PRO User Manual **EN**

Designed 
in Switzerland

Enbio S

General view

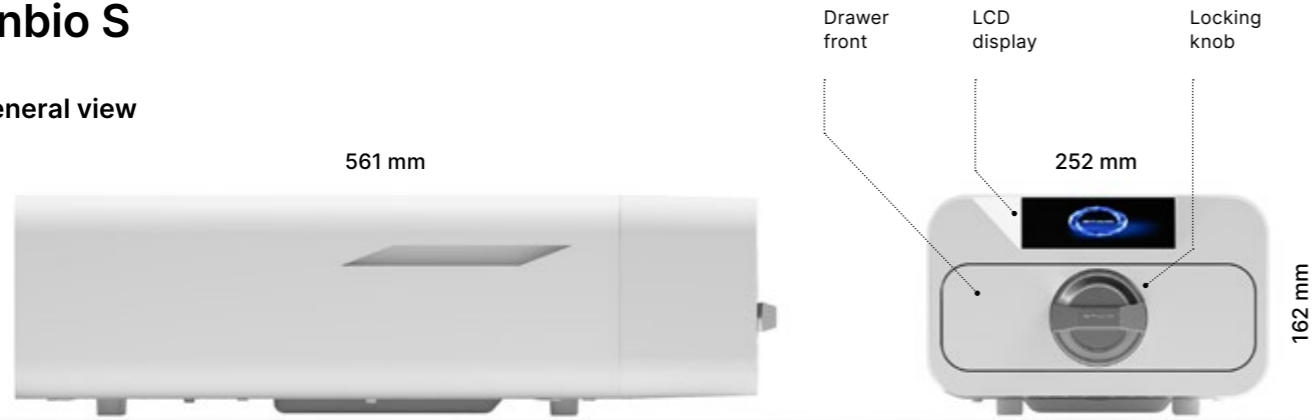

Rear view



Enbio PRO

General view

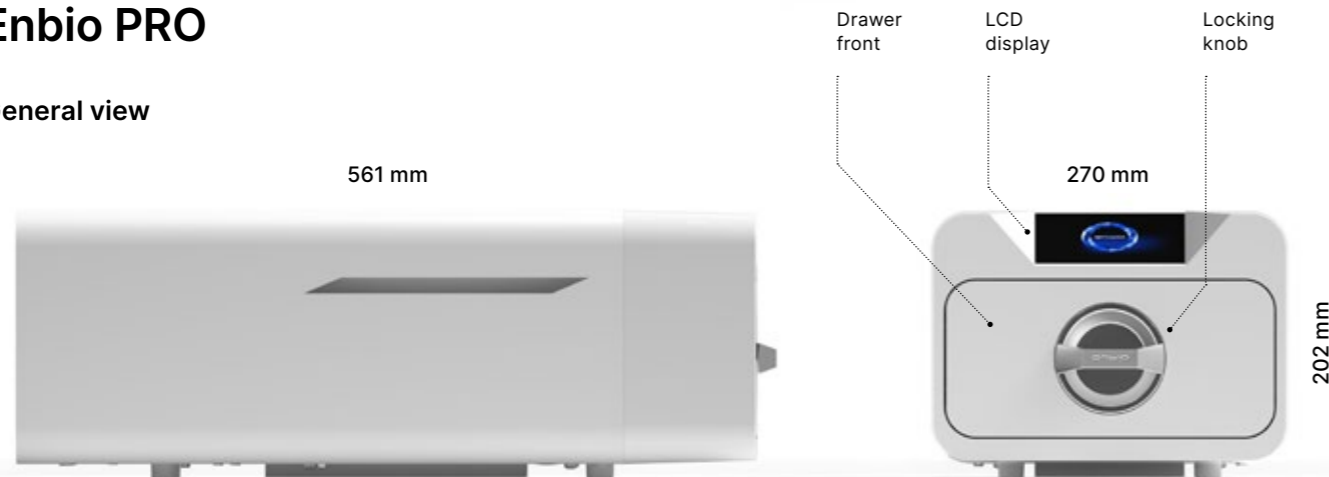

Rear view



Table of Contents

1. Introduction	2
1.1 Purpose and scope	2
1.2 Applicable legislation	2
1.3 General description of the device	2
1.4 Purpose of the device	3
1.5 Enbio S sterilization parameters	4
1.6 Enbio PRO sterilization parameters	6
1.7 Symbols used on the device	8
1.8 Precautions, requirements, recommendations	8
2. Scope of delivery and unpacking	10
2.1 Unpacking the device	10
2.2 Sterilizer accessories	11
3. Installation and preparation for operation	12
3.1 HEPA filter installation	12
3.2 Feed water quality	13
3.3 Water connection with feed and wastewater tank	14
3.3.1 Connecting the supply water WATER IN	14
3.3.2 Connecting the wastewater WATER OUT	14
3.4. Water recycling connection (Enbio Magic Filter)	16
3.4.1 WATER IN feed water connection with Enbio Magic Filter	16
3.4.2 WATER OUT wastewater connection with Enbio Magic Filter	16
3.5. Setting up the device	19
3.6. Connecting the device to the power supply	19
4. Preparation and loading of instruments	20
4.1 Preparation of packages	20
4.2 Arranging packs on sterilizer tray (sterilizing packaged loads)	21
4.3 Arranging the packages on the sterilizer tray (sterilization of loads without packaging)	21
5. Operating the device	22
5.1. First run	22
5.2 Program selection	22
5.3 Test programs	26
5.4 Info menu	31
5.4.1 LED lighting	32
5.4.2 Counters	32
5.5 Restart	35
6. Service inspections	36
7. Device maintenance	37
7.1 Consumable parts	39
8. Data archiving	41
9. Enbio Data Viewer software	42
9.1 Installing the software	42
9.2 Program structure and main functionalities	45
10. Warning messages and error codes	48
10.1 Warning messages	48
10.2 Information messages	48
10.3 Error codes	49
11. Complaint procedure	53
12. Warranty conditions	53
13. Technical data	54
14. EC declaration of conformity	56

1. Introduction

1.1 Purpose and scope

The purpose of these operating instructions is to provide information on the ENBIO S and ENBIO PRO sterilizer. In particular, information concerning:

- Intended use
- Correct installation and settings
- Correct use and operation
- Safe and reliable operation
- Regular and proper maintenance and servicing
- Handling situations

1.2 Applicable legislation

The ENBIO S and ENBIO PRO sterilizers are designed and manufactured to meet the following requirements:

- EN 13060 standard "Small Steam Sterilizers" and related documents
- Directive 93/42 / EEC on medical devices
- Directive 2012/19 / EU on waste electrical and electronic equipment (WEEE)
- Law on Medical Devices

1.3. General description of the device

ENBIO S and ENBIO PRO are small steam sterilizers designed to sterilize medical devices with steam. They have a hermetically sealed, heated chamber. The sterilized load is placed inside the chamber on a special perforated tray. After closing the chamber, the user selects and starts the appropriate sterilization program via a touch screen. Sterilization proper begins after the pre-vacuum phase. The steam generator generates steam and introduces it into the chamber. This steam transfers its energy to the sterilized load. Inside the chamber, the correct temperature and pressure, depending on the sterilization cycle selected, are maintained for a specific period of time. After this time, the chamber is emptied of steam and the drying cycle begins. When the sterilization process is complete, the device displays a summary information and the result of the process to the user.

1.4. Purpose of the device

The ENBIO S and ENBIO PRO devices are small class B steam sterilizers in accordance with the EN 13060 standard; they are also classified as class IIb medical devices according to Annex IX of the Medical Devices Directive 93/42 / EEC.

The devices are suitable for sterilizing loads for which steam sterilization is specified. The following medical devices can be sterilized in the ENBIO S and ENBIO PRO: solid loads, small porous items, small porous loads, full porous loads, simple hollow items, items with narrow clearance, multiple packages that can be unpackaged or packaged (single- or multi-layer). The 134°C FAST process is dedicated exclusively to solid, non-porous, simple instruments and dental instruments (e.g. scissors, handles, pliers, chisels, probes, etc.) only unpackaged, non-textile.



The ENBIO S and ENBIO PRO are not designed to sterilize liquids, pharmaceutical products, biomedical waste or materials incompatible with steam sterilization. Processing such loads may result in improper sterilization and/or damage to the autoclave and pose a risk to user/patient safety.

The ENBIO S and ENBIO PRO devices can be used in primary health care practices, in dental practices, and in treatment rooms. The sterilizers, which comply with the guidelines of the ISO 13060 standard, are suitable for operation in the environment of other electrical medical devices.

The Enbio PRO sterilizer has a PRION program dedicated to one of the decontamination steps for items suspected of having or may have come into contact with transmissible prion protein (e.g. Creutzfeldt-Jakob disease, BSE, etc.). Detailed information and recommendations for infection control of transmissible spongiform encephalopathies are provided in the document "WHO Infection Control Guidelines for Transmissible Spongiform Encephalopathies - Report of a WHO consultation. (Geneva, Switzerland, 23-26 March 1999)". It is the responsibility of the user of this device to follow these guidelines and any local/national guidelines.

Non-medical use:

The ENBIO S and ENBIO PRO devices can also be used for non-medical applications, e.g. in beauty and wellness salons, veterinary practices, cosmetic surgeries, tattoo studios, piercing studios and hairdressing salons.

The devices are intended for professional use only by properly trained staff.

1.5. Enbio S sterilization parameters

The table below, which presents the characteristics of the individual sterilization programs in the Enbio S device, should be read in detail. It is the user's responsibility to select the program appropriate to the type of load and not to exceed the maximum weight of the sterilized load. Failure to comply with the following rules may endanger the health of patients and the operation of the device.

Enbio S

Program name	Description of the load	Sterilization temperature	Sterilization time	Drying time	Max. load weight	Number of pre-vacuums	Total process time (for a load of specified weight)*	Max. water consumption	Sterilization process class
134°C	solid loads, small porous objects, small porous loads, full porous loads, simple dimpled objects, narrow clearance objects, multiple packages that may be unpackaged or packaged (single or multiple layers)	134°C	4 minutes	3 minutes	500 grams	3	load of 100 grams ≈ 13 minutes	115 ml	B
121°C	solid loads, small porous objects, small porous loads, full porous loads, simple dimpled objects, narrow clearance objects, multiple packages that may be unpackaged or packaged (single or multiple layers)	121°C	15 minutes	5 minutes	500 grams	3	load of 100 grams ≈ 26 minutes	110 ml	B
134°C FAST **	solid, non-porous, simple dental instruments and appliances (e.g. scissors, handles, pliers, chisels, probes, etc.) only unpackaged, non-textile	134°C	3.5 minutes	no drying	500 grams	1	load of 100 grams ≈ 7 minutes	105 ml	S

* Ambient temperature can have an effect on increasing the total process time.

* The total duration of the first process may be longer due to the need for the appliance chamber to warm up.

** After sterilization at 134°C FAST the loads are wet. It is recommended to leave the drawer ajar in order to evaporate the remaining water and to lower the temperature of the instruments.

** After sterilization in the 134°C FAST program, the instruments are intended for immediate use.

1.6. Enbio PRO sterilization parameters

The table below shows the characteristics of each sterilization program in Enbio PRO. It is the user's responsibility to select a program suitable for the type of load and not to exceed the maximum weight of the sterilized load. Failure to observe the following precautions may compromise patient health and device operation.

Enbio PRO

Program name	Description of the load	Sterilization temperature	Sterilization time	Drying time	Max. load weight	Number of pre-vacuums	Total process time (for a load of specified weight)*	Max. water consumption	Sterilization process class
134°C	solid loads, small porous objects, small porous loads, full porous loads, simple dimpled objects, narrow clearance objects, multiple packages that may be unpackaged or packaged (single or multiple layers)	134°C	4 minutes	4 minutes	800 grams	3	load of 200 grams ≈ 18 minutes	190 ml	B
121°C	solid loads, small porous objects, small porous loads, full porous loads, simple dimpled objects, narrow clearance objects, multiple packages that may be unpackaged or packaged (single or multiple layers)	121°C	15 minutes	5 minutes	800 grams	3	load of 200 grams ≈ 31 minutes	180 ml	B
134 ° C FAST **	solid, non-porous, simple dental instruments and appliances (e.g. scissors, handles, pliers, chisels, probes, etc.) only unpackaged, non-textile	134°C	3.5 minutes	no drying	800 grams	1	load of 100 grams ≈ 10 minutes	140 ml	S
134 ° C PRION	solid loads, small porous objects, small porous loads, full porous loads, simple dimpled objects, narrow clearance objects, multiple packages that may be unpackaged or packaged (single or multiple layers)	134°C	18 minutes	5 minutes	800 grams	3	load of 800 grams ≈ 45 minutes	230 ml	B







* Ambient temperature can have an effect on increasing the total process time.

* The total duration of the first process may be longer due to the need for the appliance chamber to warm up.

** After sterilization at 134°C FAST the loads are wet. It is recommended to leave the drawer ajar in order to evaporate the remaining water and to lower the temperature of the instruments.

** After sterilization in the 134°C FAST program, the instruments are intended for immediate use.

1.7. Symbols used on the device

	This symbol is located on the front of the appliance, on top of the drawer front, and advises extreme caution due to the high temperature of the compartment and its immediate surroundings.
	This symbol is located on the unit's rating plate and identifies its individual serial number.
	This symbol appears on the unit's rating plate and identifies the Notified Body involved in the conformity assessment process for Directive 93/42/EEC.
	This symbol is located on the unit's rating plate and identifies the year the unit was manufactured.
	This symbol is located on the equipment rating plate and identifies the equipment manufacturer.
	This symbol can be found on the unit's rating plate and requires the user to read and follow the information in this manual.
	This symbol is located on the unit's rating plate and identifies the Authorized Representative.

- The correct and safe operation of the device is based on a thorough reading and observance of this document, on the installation and use of the device in accordance with the descriptions given therein and on the observance of all safety conditions. Any other use, not complying with this manual, may lead to dangerous accidents, for which the manufacturer will not be held responsible.
- Access to the device must be restricted to unauthorized persons and the operating personnel must be trained. Operating personnel are understood to be persons who, as a result of their training, experience and knowledge of the relevant standards, documentation and regulations relating to safety and working conditions, are authorized to carry out sterilization and who can recognize possible dangers and avoid them.
- This document must be supplied with the appliance; it contains detailed information on assembly and installation as well as commissioning, use, repair and maintenance. If the appliance is operated as intended, this manual contains sufficient information necessary for qualified personnel.
- This document should always be kept near the device and easily accessible.
- The manufacturer reserves the right to make changes that do not affect the safety of operation and maintenance of the device, without notice to users.
- The manufacturer shall not be liable for damages during the period of waiting for service, inspections and warranty repairs, or any other damage to the Customer's property other than the device, in particular for errors resulting from improper installation or incorrect operation of the device.
- Failure to follow the instructions in this document may endanger the safety of the device user and patients.
- The user must follow all unpacking, installation and operation guidelines - otherwise the warranty is void.
- In particular, the user must ensure the availability of water of adequate quality - under the pain of losing the warranty.
- It is unacceptable to use any liquids, solutions, chemicals in the sterilization process - the device can be powered only with water of appropriate quality. The use of water of incorrect quality or solutions other than water will void the warranty.
- It is the user's responsibility to perform timely maintenance and inspections of the device - under penalty of losing the warranty.
- It is the user's responsibility to select a program appropriate to the type of load and not to exceed the maximum weight of the load to be sterilized.

1.8. Precautions, requirements, recommendations

- The user is responsible for the correct installation, proper use and maintenance of the unit in accordance with the guidelines in this document. If necessary, contact the service department or your device supplier.
- The sterilizer must not be used in the presence of flammable gases or explosive vapors in the ambient air.
- At the end of each sterilization cycle, the load is hot. Instruments or packages should be removed from the chamber using appropriate protective gloves or other equipment to prevent burns.
- Do not remove the rating plate or other markings from the unit - otherwise the warranty will be void.
- Do not disassemble the unit's housing or other parts - otherwise the warranty will be void.
- Follow the guidelines for preparing instruments for sterilization.
- Flooding the device with water or other liquids may cause a short circuit and threaten the user's safety.
- Turn off the unit and disconnect the power supply before inspecting, performing maintenance, or servicing.
- Inspection and servicing of the device may be carried out only by trained service technicians using original spare parts.
- After sterilization at 134°C FAST the loads are wet. It is recommended to leave the drawer ajar to evaporate the remaining water and to lower the temperature of the instruments.
- ** After sterilization in the 134 ° C FAST program, the instruments are intended for immediate use.

2. Scope of delivery and unpacking the device

2.1. Unpacking the device



If the sterilizer has been transported or stored at a temperature and humidity different from that in the place of installation, wait at least 60 minutes after delivery. If the device is moved from a cold to a warm place, it may contain humidity which, by adversely affecting the electrical components of the device, may damage it when it is turned on.



Carefully unpack the device from its packaging.



The packaging and its contents should be checked for external damage. In the event of damage, immediately contact the seller or the transport company to write a damage report. Do not use the device.



It is recommended to leave the carton for possible transportation of the autoclave.



Used electrical and electronic equipment must not be placed, thrown away or stored with other waste. Used equipment should be delivered to a local collection point for used electrical equipment, which is registered with the respective environmental protection office and conducts selective waste collection.

2.2. Equipment of the sterilizer

Before starting the installation, it is recommended to check the contents of the package. The following items should be included in the package

1. Enbio S / Enbio PRO sterilizer
 2. HEPA filter (inside the chamber of the device).
 3. Power cord.
 4. Water and condensate connection hoses (blue and red) with plastic plugs.
 5. Enbio Magic Filter water filter
 6. USB flash drive.
 7. User manual*
 8. Device validation report
 9. TÜV * certificate
 10. Enbio Medical Sterilization sticker
 11. Warranty*
 12. Enbio Data Viewer software *
- * - electronic version on pendrive

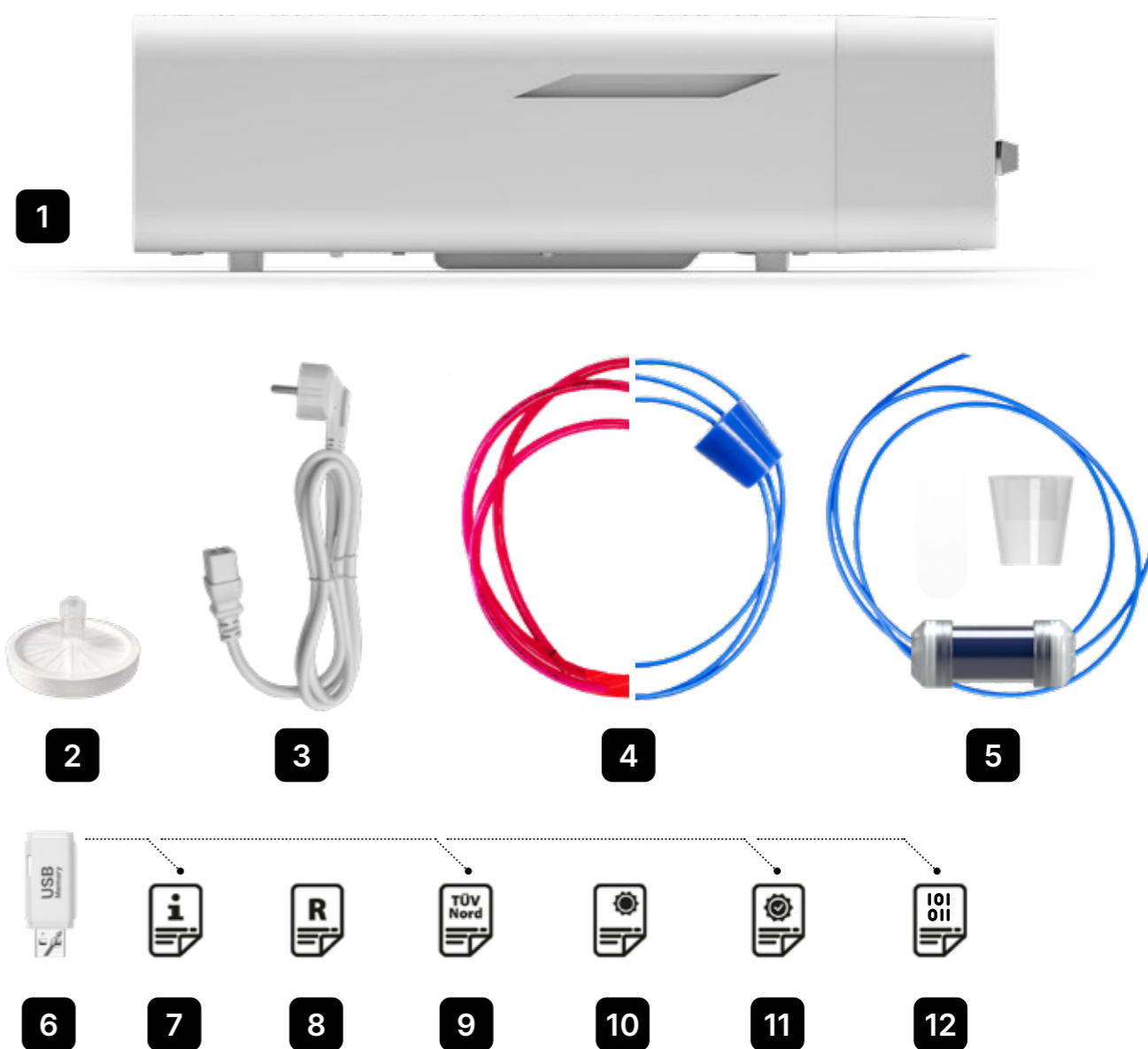

3. Installation and preparation for operation



Please read these operating instructions carefully before using the ENBIO S or ENBIO PRO. During operation, observe the guidelines in these instructions as well as the applicable local health and safety rules. The ENBIO S and ENBIO PRO units are designed for self-assembly by the user and do not require specialized installation on site. The user is responsible for proper installation of the unit on site in accordance with these instructions.

3.1. HEPA filter installation.



To protect the component during transport, a HEPA filter is not installed in the device. It was placed inside the chamber, on a tray. Take it out of the chamber, take it out of the bag and by yourself, carefully screw it into the slot provided for this purpose (see fig.). The filter should be screwed in by hand (approx. 7 turns) until resistance is felt - further screwing in will damage the filter and immobilize the sterilizer.



3.2. Feed water quality

It is unacceptable to use any liquids, solutions, chemicals, additives to the feed water - the device may be powered only with demineralized or distilled water of appropriate quality.

No chemicals or additives must be added to the sterilization water, even if they are specifically intended for use in steam generators, steam production or for use as additives in sterilization, disinfection, cleaning or corrosion protection.

The use of incorrect quality water or solutions other than water reduces the effectiveness of sterilization and leads to damage to the device and loss of warranty.

The total mineral content of the sterilization water must be less than 10 ppm or, in the case of conductivity measurement, it must be less than 15 $\mu\text{S}/\text{cm}$ - therefore tap water cannot be used as feed water for the device.

The table below shows recommended water hardness and conductivity parameters for Enbio S and Enbio PRO sterilizers.

Permissible parameters of water used for sterilization

- hardness $<0.02 \text{ mmol / l}$
- conductivity (at 20°C) $<15 \mu\text{S / cm}$
- pH - from 5 to 7.5
- chemical additives - none



The use of water with an impurity content in excess of the above levels will damage the device and will void the warranty.



The water in the supply tank should be replaced at least every three months (due to increased conductivity due to prolonged contact with air). If the tank is dirty, also change it to a new one. The tank should be closed with the attached stopper so that water does not deteriorate its chemical composition as a result of contact with air.



The guarantee granted by the manufacturer becomes void if the autoclave has been used with water of a quality inconsistent with the recommended



If the autoclave is operated in a water recycling system using the Enbio Magic Filter, the filter must be replaced with a new one every 6 months or less when the resin has completely discolored to an amber color. As long as the blue color is visible, the resin has still water-purifying properties, i.e. water hardness $<0.02 \text{ mmol / l}$ and conductivity $<15 \mu\text{S / cm}$. In order to ensure the correct parameters of the water supplying the device, it is recommended to check the water tank at least quarterly. In the event of contamination, the tank should be emptied, cleaned and filled with new demineralized water. Failure to comply with these obligations may disrupt the sterilization process and will void the warranty on the sterilizer.

3.3. Water connection with feed and wastewater tank

To connect the Enbio autoclave, you need 2 water tanks (feed and waste) of identical capacity, or a feed water tank and drainage access to the sewage system.

3.3.1 Connecting the WATER IN feed water

- Connect the blue connection hose to the blue feedwater connection, which is marked on the rear panel of the WATER IN device. The tubing should be inserted into the connector, to the depth of the black line (placed on the tubing).
- The other end of the blue tube should be immersed in the tank with the feed water. The device is equipped with a water suction pump, so it is not necessary to place the water tank above or on the same level as the device.
- To secure and immobilize the water supply hose to the machine, use the plug supplied with the hose and insert the plug into the opening of the water supply tank. An unsecured tubing may jump out of the water and cause sterilization errors.
- To prevent the hose from coiling in the water tank, install the included weight with a rubber ring at 2 cm from the end of the hose (fig.)
- The minimum water load in the tank is 300 ml.
- Remember and check that the blue tube is always immersed in the water.
- Check the water level in the tank on a regular basis, depending on the frequency of the processes

3.3.2 WATER OUT Wastewater connection

- Connect the red wastewater hose to the orange wastewater connector that is marked on the rear panel of the WATER OUT device. The tubing should be inserted into the connector, to the depth of the black line (placed on the tubing).
- Wastewater should be discharged directly to the water and sewage system or to a special wastewater tank. If a tank is used, the other end of the red tube should be placed in the wastewater tank. To secure and immobilize the water drain hose from the machine, use the plug provided with the hose and insert the plug into the opening of the wastewater tank. The unsecured tubing may jump out of the tank and flood the room.
- Make sure that the red tube is never immersed in water, otherwise the water will not drain properly, causing sterilization errors.
- The wastewater tank or drainage outlet must always be located below the unit.
- When using wastewater tanks, we recommend that you use tanks with the same capacity as the feed water tank. Their simultaneous replacement will protect against the possibility of wastewater overflow.
- The water level in the tank should be checked on a regular basis, depending on the frequency of the processes.

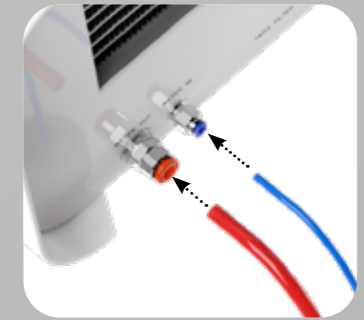
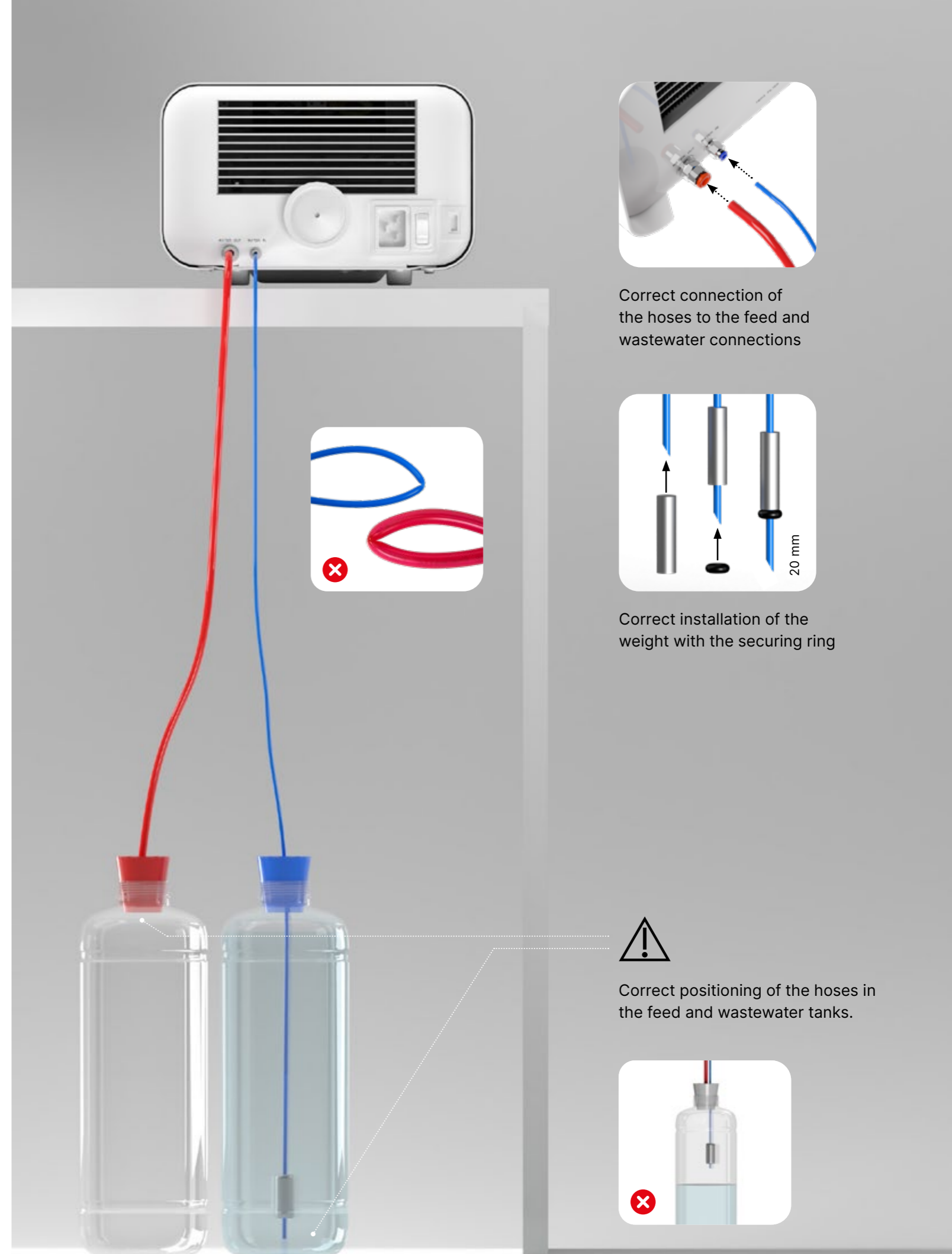

Correct connection of the hoses to the feed and wastewater connections

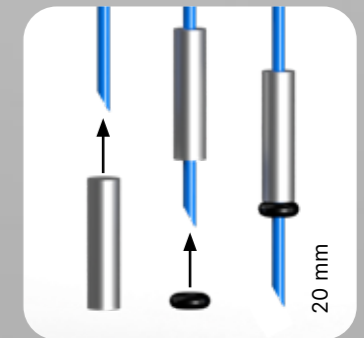

Correct installation of the weight with the securing ring



Correct positioning of the hoses in the feed and wastewater tanks.



3.4. Connection with water recycling (Enbio Magic Filter)

Enbio Magic Filter is a filter for recycling water used in the sterilizer. The ion-exchange resin contained in Enbio Magic Filter allows you to purify wastewater to the level of deionized water in accordance with the requirements of EN 13060 - that is, water which is recommended and approved for use with Enbio autoclaves. You only need 1 water tank to use Enbio autoclave with filter.

3.4.1 Connection of feedwater WATER IN with Enbio Magic Filter

- Connect the shorter part of the blue Enbio Magic Filter connection hose to the blue water supply connection, which is marked on the rear panel of the WATER IN device. The tubing should be inserted into the connector, to the depth of the black line (placed on the tubing).
- Submerge the longer part of the blue Enbio Magic Filter hose into the feed water tank. The unit is equipped with a water intake pump, so there is no need to place the water tank above or at the same level as the unit
- To ensure proper operation, Enbio Magic Filter must always be placed in a vertical position
- To prevent the hose from coiling in the water tank, install the included weight with a rubber ring at 2 cm from the end of the hose (fig.)
- To secure and immobilize the water supply hose to the machine, use the plug supplied with the Enbio Magic Filter and insert the plug into the opening of the water tank. An unsecured tubing may jump out of the water and cause sterilization errors.
- The minimum water load in the tank is 300 ml.
- Remember and check that the blue tube is always immersed in the water.
- Check the water level in the tank on a regular basis, depending on the frequency of the processes

3.4.2 WATER OUT wastewater connection with Enbio Magic Filter

- Connect the red wastewater hose to the orange wastewater connector that is marked on the rear panel of the WATER OUT device. The tubing should be inserted into the connector, to the depth of the black line (placed on the tubing).
- Wastewater should be drained into a water tank. To secure and immobilize the water drain hose from the unit, use the plug supplied with Enbio Magic Filter and insert the plug into the opening of the water tank. The unsecured tubing may jump out of the tank and flood the room.
- Make sure that the red tube is never immersed in water, otherwise the water will not drain properly, causing sterilization errors.
- The water tank must always be located below the unit.

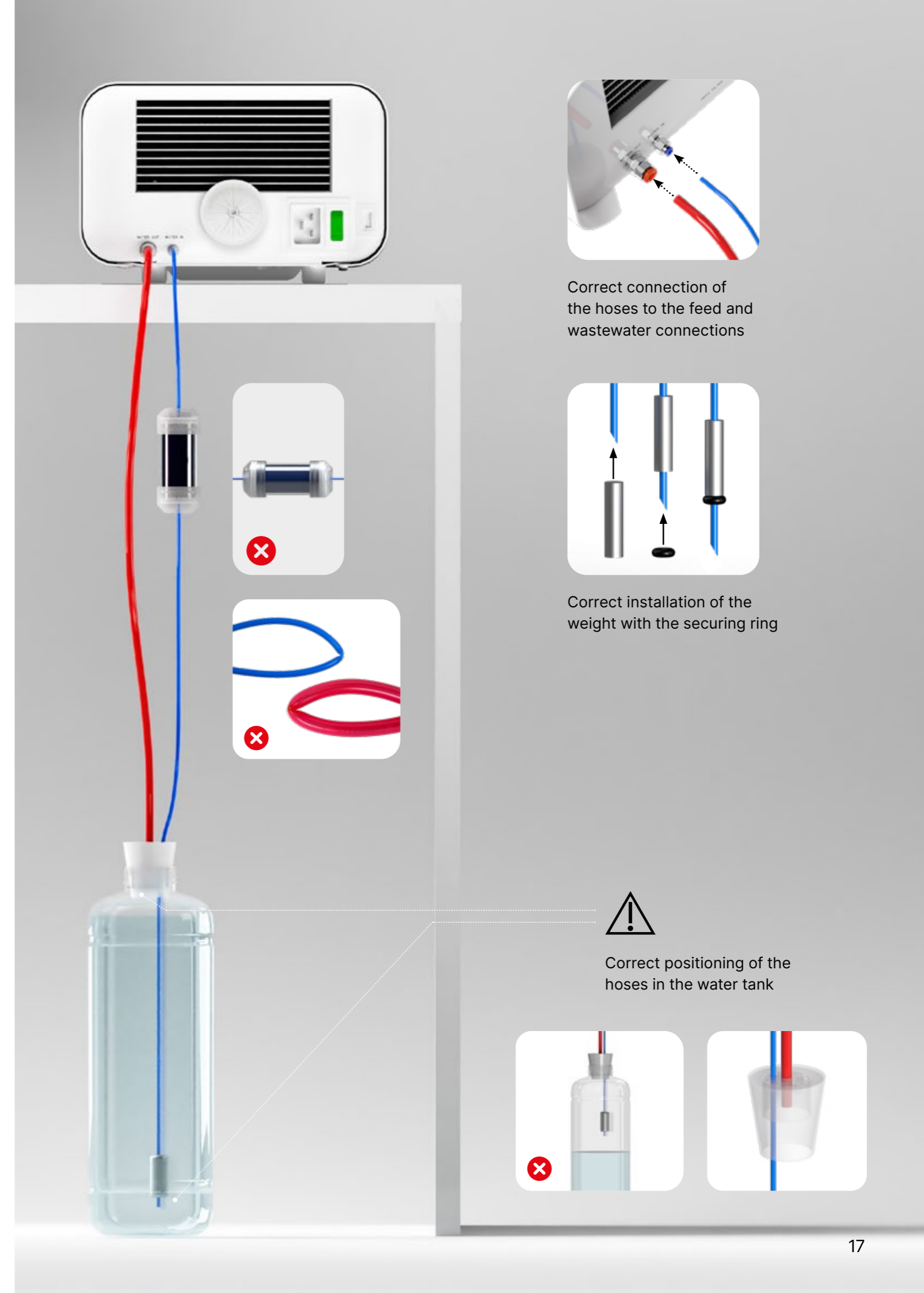

Correct connection of the hoses to the feed and wastewater connections

Correct installation of the weight with the securing ring



Correct positioning of the hoses in the water tank



3.5. Setting up the device

- The unit should be placed on a flat, level surface. Do not use the unit if it is at an angle.
- Only demineralized or distilled water should be used in the devices. The use of incorrectly specified water (see "3.2. Supply water quality") reduces the sterilization efficiency and leads to loss of warranty due to damage to the device.
- Leave a space of 5 cm at the rear of the appliance and at least 1 cm at the sides of the appliance from walls or other elements for proper ventilation and fresh air access.
- The unit should be located to provide easy access to the main switch located on the rear panel of the unit.
- Do not place the unit near a sink with water or other places where the unit could be flooded - danger of short circuit.
- The device should be installed in a well-ventilated room, far from heat sources and rooms where mixtures of gases or liquids or other dangerous factors may arise.

The following conditions must be ensured for safe and efficient operation of the device:

- ambient temperature from + 5 ° C to + 25 ° C,
- relative humidity from 0 to 90%,
- storage temperature from -20 ° C to + 60 ° C,
- 0 to 90% relative humidity.

3.6. Connecting the device to the power supply

Connect the appliance only to power sources that are grounded and equipped with residual current protection, and that have the same voltage rating as the appliance (see "12. Technical Data"). It is unacceptable to use extension cords to connect the device to the power source. Connecting the device to an incorrect power source may damage it and void the warranty.

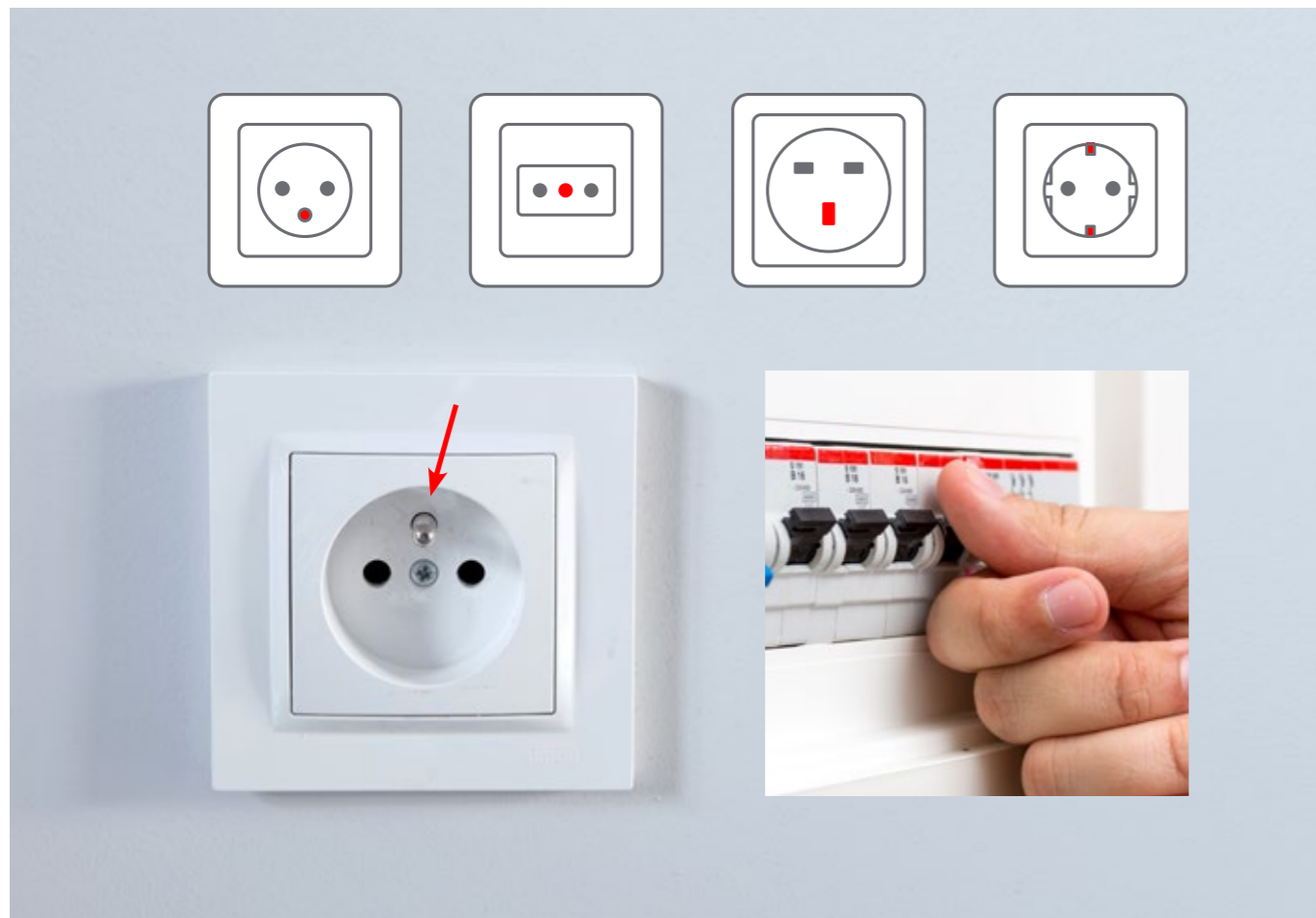

4. Preparation and loading of instruments

The devices are suitable for sterilization of loads for which steam sterilization is stipulated. The instruments must be sterilized only if they are clean and dry. Therefore they must be washed and disinfected before being loaded onto the tray in accordance with applicable regulations. Residues of used chemicals or other solid particles may render the sterilization process impossible or even damage the device. In addition, sterilization of instruments that have not been previously cleaned and disinfected is a biological hazard and can lead to damage (both to the instruments and to the sterilizer). For instruments that must be lubricated, use steam sterilization lubricants. Excess lubricant must also always be removed

- The 134 ° C FAST program is intended only for sterilization of unwrapped instruments (see "1.5 Enbio S Sterilization Parameters" and / or "1.6 Enbio PRO Sterilization Parameters").
- After sterilization with 134°C FAST the instruments are moist - it is recommended to leave the drawer open for a few minutes to evaporate excess moisture.
- After sterilization of unpackaged loads, they are intended for immediate use.

4.1. Preparation of packages

It is recommended to use sterilization packaging that meets the requirements of EN ISO 11607-1: 2020 and EN 868-2: 2017. Appropriate packaging should:

- ensure good penetration of the sterilizing agent into the inside of the package,
- provide resistance to damage during the sterilization process,
- ensure tight and durable sealing of contents and safe removal for use,
- provide a barrier to microorganisms and unwanted substances and contaminants,
- Use disposable sterilization sleeves (intended for steam sterilization) as recommended by their manufacturer
- sleeves should only be filled to about 3/4 full to allow for proper sealing and minimize the risk of damage to the package
- a distance of at least 30 mm should be maintained between the seals and the sterilized load. 30 mm
- the sharp edges of the load should be protected to avoid damaging the packaging
- the packaging material must not be placed too loosely or be tightly stretched so as not to affect pressure variations during sterilization
- a label with information about the contents of the package, the code of the packer, date of sterilization and use-by date as well as parameters of the sterilization process should be placed on the package



Example of a packed load.



Example of an unpacked load.

4.2. Arranging packages on the sterilizer tray (sterilization of packed items)

- packets on the tray should be placed so that the paper side touches the paper side, because penetration of the sterilizing agent and air exchange can only take place through the paper
- the packages should be placed on the tray in such a way as to eliminate the contact of the package with the door seal and the phase of the sterilization chamber - failure to comply with this rule may cause the chamber to become unsealed and the sterilization cycle incorrectly carried out
- the edges of the packs must not protrude beyond the sterilizer tray, as this would cause the chamber to leak and the sterilization cycle to fail
- if the sterilizer chamber is heavily loaded, the first packs must face the foil side towards the bottom of the tray (this ensures faster and more efficient drying of the packs).

4.3. Arranging tools on the sterilizer tray (sterilization of loads without packaging)

- in the case of sterilization without packages - the instruments must be placed in such a way that they do not have direct contact with each other, no element of them falls into the openings of the tray, and does not rest against the edge of the tray or protrude beyond its outline
- Failure to follow the above recommendations may cause permanent and irreversible damage to the sterilization chamber phase, which will result in the lack of tightness of the sterilizer and loss of warranty



Do not exceed the maximum load weight: 500 g for Enbio S devices and 800 g for Enbio PRO devices. In order to verify the correctness of the performed sterilization, it is recommended to place a sterilization chemical indicator in the chamber for each process, which discoloration during properly conducted sterilization.

5. Operating the device

5.1. First run

Turn on the device using the main switch located on the rear panel of the device. Make sure that the supply and wastewater hoses are connected correctly, and that there is water in the supply tank and the wastewater tank is empty. Place the load on the tray, slide the drawer in and lock it, i.e. turn the knob clockwise. The sterilizer provides audible information about changes and the completion of the process.

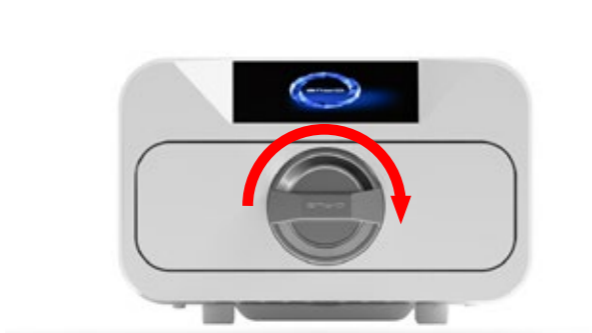

5.2 Program selection

Depending on the type of load to be sterilized, the user must select the appropriate program - in accordance with the instructions of the sterilizer manufacturer (see sections: "1.4 Intended use of the device", "1.5 Enbio S sterilization parameters" and "1.6 Enbio PRO sterilization parameters") and the load manufacturer's recommendations.

- Carrying out sterilization processes in the ENBIO S / ENBIO PRO device does not affect the biocompatibility of the materials.
- All device components that come into direct contact with the sterilized load do not cause toxicity, sensitization or irritation.



Process selection screen **Enbio S**



Process selection screen **Enbio PRO**



After switching on the device, the start screen appears on the display. To go to the next screen, press the screen once with your finger (anywhere).



This screen only appears on first run, before the first process is performed.

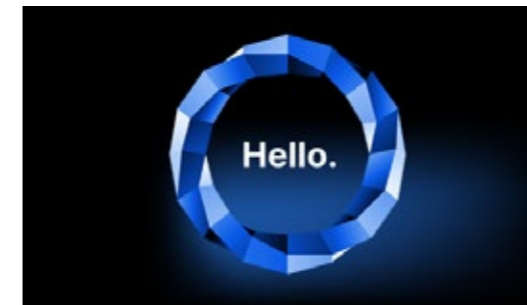

Each time the device is switched on again, the welcome screen appears in the display. To go to the next screen, press the screen once with your finger (anywhere).

On the next screen, we can go to sterilization, test the device or open the information menu. The following sterilization programs can be selected from the main menu: 121 ° C, 134 ° C, 134 ° C FAST and 134 ° C PRION (Enbio PRO only).

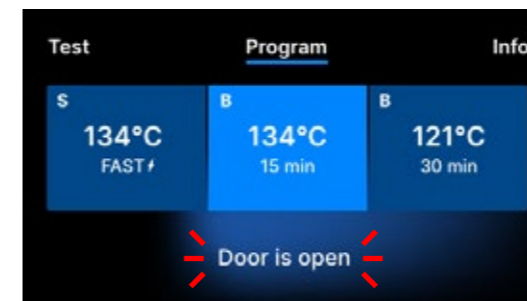

When the chamber is opened, the DOOR OPEN symbol flashes.

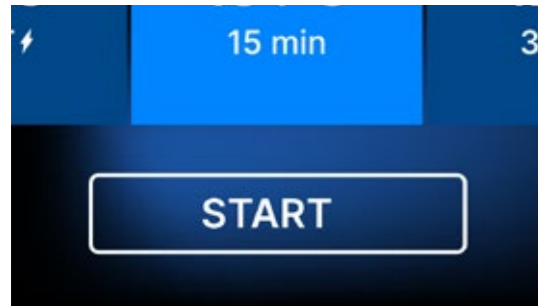

When the chamber is closed by turning the locking knob clockwise, the START symbol appears on the display, which informs that the chamber is properly closed.

Now we can select the program by pressing the appropriate symbol of the temperature in which we want to sterilize 121 ° C, 134 ° C, 134 ° C FAST or 134 ° C PRION, which will highlight the selected program. The selected program is started by pressing the START symbol.



If the USB memory is not inserted in the device, the USB disk symbol is not displayed in the lower right corner of the screen.

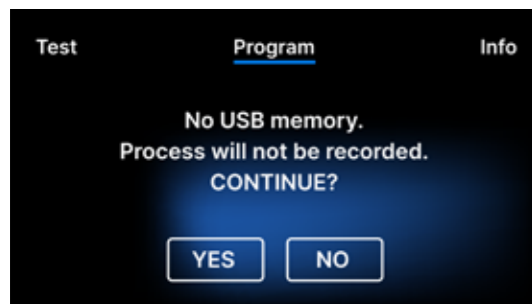

A message appears that USB memory is missing. The program data will not be saved. We can continue working without saving data to the USB memory stick by pressing the YES box, or abort the work by selecting the NO box to place the stick in the port and start the program steps from the beginning.

It is recommended to use a USB drive with each of the processes. The data stored on it will allow you to print reports from selected processes.

If work continues or the START field has been selected, a symbolic pressure diagram of the entire process is displayed on the screen with the current program progress highlighted against a background and information on the next process steps in the upper left corner of the screen. During the program run, the screen displays the temperature of the selected sterilization program or the current temperature in the process chamber in the lower left corner, the current pressure in the chamber in the lower right corner, and the time remaining until the end of the process in the upper right corner of the screen. This is an estimated time, which may be increased due to the weight and type of the load.

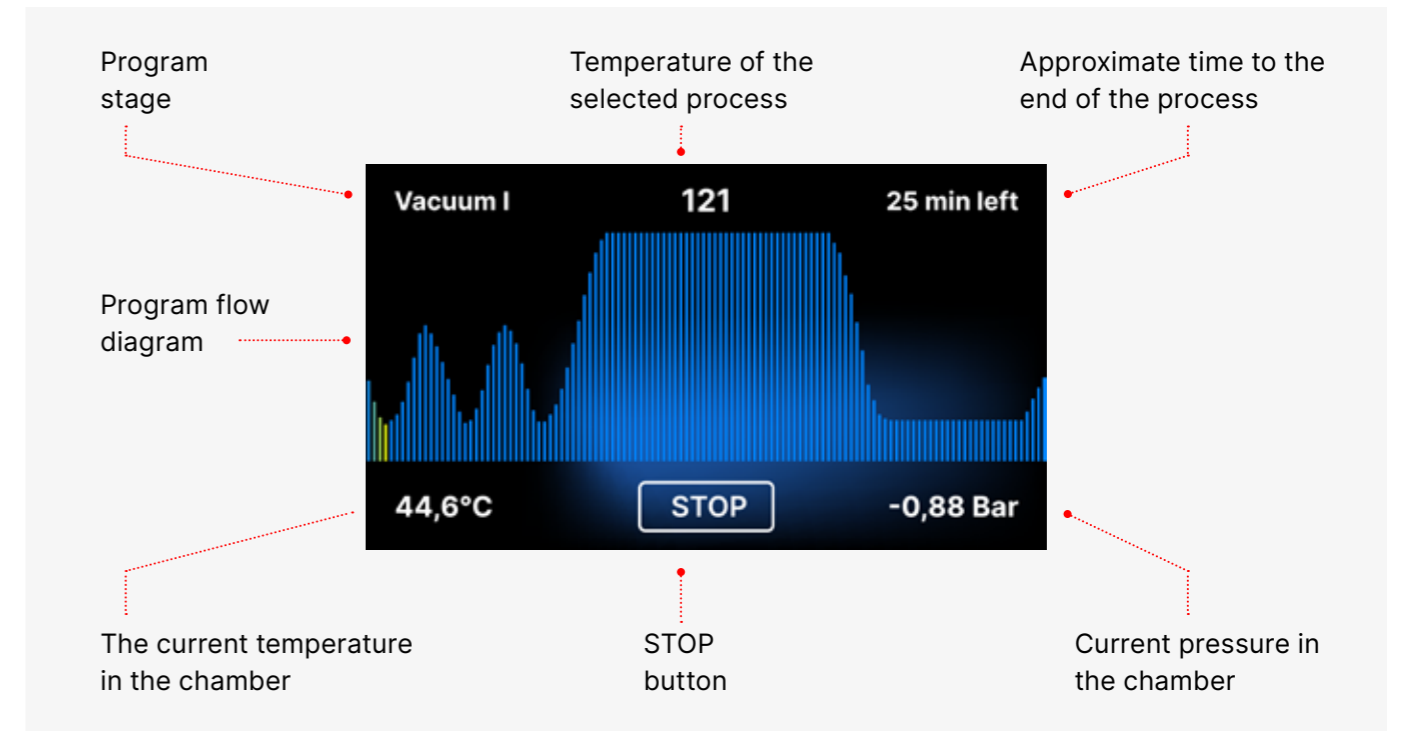

During the course of the program, in place of the START field, the STOP field is displayed, which allows the user to stop the process at any time. In the upper left corner of the screen, the names of the individual stages of the program are displayed consecutively, e.g. chamber lock, heating of the working chamber

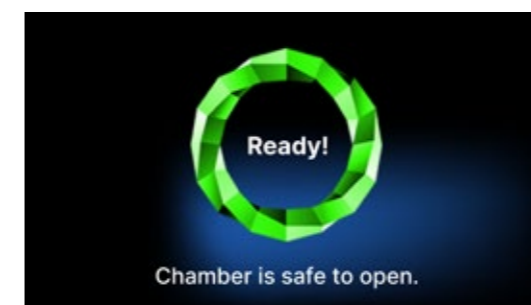

If the process was successful, the display alternately shows information screens about the end of the process and the sterility of the load and about the possibility of opening the chamber of the device. By pressing the FINISH field, we go to the welcome screen.



WARNING! After the process, the chamber, tray and load are hot. Be especially careful and use protective gloves to remove the load or wait until it cools down. In the 134C FAST program, instruments are hot and wet after sterilization.

5.3 Test programs

The devices are equipped with special test programs to verify the correct operation of the sterilizer.

Enbio S / Enbio PRO	Bowie & Dick / Helix	Vacuum test
Process temperature	134°C	–
Number of pre-vacuums	3	1
Sterilization time	3.5 min	–
Drying time	3 min	–
Total process time	15 min	16 min



By pressing the Test field you go to the test programs menu. From this level, we can choose between the Vacuum test and Helix / B&D test programs. We select the appropriate program by pressing the required field on the display.



When the device working chamber is closed, the word DOOR OPEN changes to START and by pressing this field the selected test program is started.

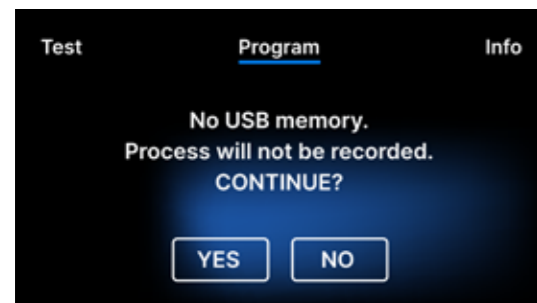

If a USB flash drive has not been inserted into the unit, the USB symbol is not displayed in the lower right corner of the screen and a message indicating no USB flash drive is displayed. The test program data will not be saved. We can continue without writing data to the USB flash drive by pressing the YES box or abort by selecting the NO box to place the USB flash drive in the port and start the program from the beginning.

Vacuum test

The vacuum test should only be performed on a cold device before starting work. During the test, the device verifies:

- vacuum pump capacity.
- tightness of the pneumatic system.



After selecting a vacuum test program and starting it with the button, the vacuum test program run screen is displayed, with Information about loss of pressure in the working chamber and the duration of the test.

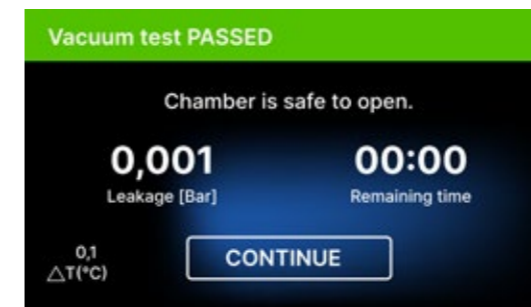

[Vacuum test PASSED]
When the test program ran successfully.

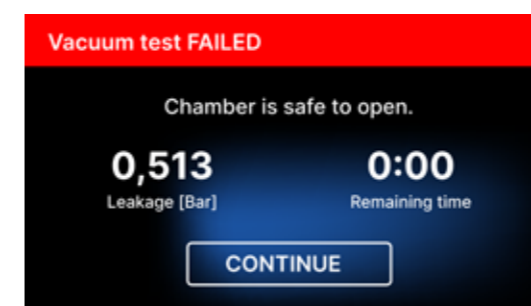

[Vacuum test FAILED]
When the test program did not run successfully.



After pressing the CONTINUE field, the welcome screen is displayed.

During the vacuum test the sterilizer chamber must be completely dry and cold. If not, the vacuum test may not be reliable even if the sterilizer is fully operational. When the test is complete a message indicating the result will appear on the display. If the result is negative check, clean or replace the seal, clean the front edge of the chamber and repeat the test. If the Vacuum test fails again, contact the supplier or manufacturer.

Bowie & Dick test

The Bowie & Dick test, also known as the steam penetration test, simulates a small, highly porous load. To perform the test it is necessary to have a special test packet and placed inside the chamber. The package is not an accessory of the device, the user should purchase it on his own.

This test evaluates the device's performance in sterilizing loads of porous objects:

- Pre-vacuum performance and steam penetration.
- Temperature and pressure of saturated steam reached for a certain period of time.

How to run the test:

- The test must be carried out with an empty chamber in accordance with EN 13060.
- Place the Bowie-Dick test package in the chamber in the center of the tray.

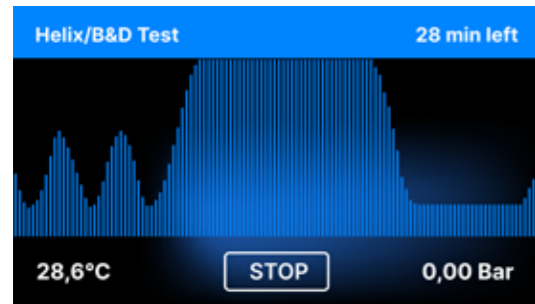

After selecting the Helix / B & D test program and starting it with the START button, the program sequence screen is displayed.

Information about the process parameters is displayed.

The Helix / B & D test program can be stopped at any time by pressing the STOP field, which is associated with incorrect termination of the test.

When the test program is complete, alternating screens are displayed:

[READY] Test complete / [READY] Chamber is safe to open.

The process chamber of the sterilizer can be safely opened.

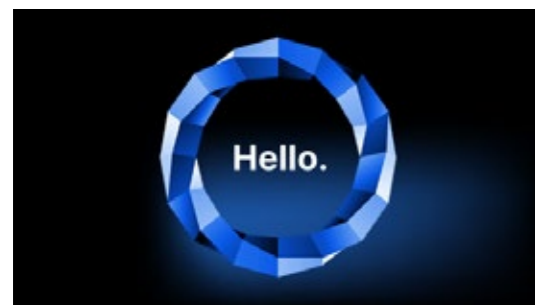
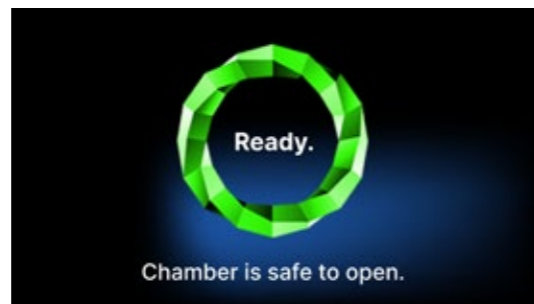
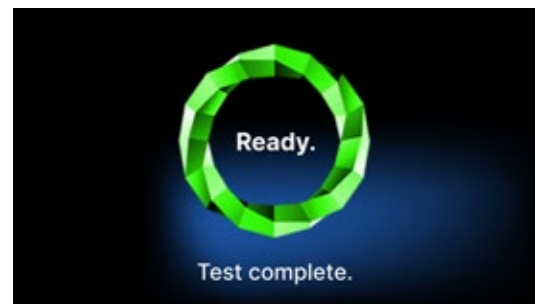

After opening the process chamber, the welcome screen is displayed.

The control test should be removed.



WARNING! The package will be hot.

To correctly interpret the test, refer to the instructions provided by the test manufacturer.

Open the package and remove the indicator chemical from the center of the package.



Positive result

The chemical indicator turned a uniform dark color over the entire surface.



Negative result

A bright field remained in the middle of the test because of the remaining air inside the tested device.

Any color change, uneven coloring of the test, indicates the presence of air during the test cycle due to a malfunction of the sterilizer. If the test result is abnormal, check the expiration date of the test pack and repeat the test.

Helix test

The Helix test corresponds to the sterilization of instruments with A-holes in accordance with EN 13060. It consists of a 1500 mm long tube open on one side and a closed test capsule on the other side. The indicator strip is inside the test capsule.



Helix test kit

This test is used to evaluate the efficiency of the device in the sterilization of hollow and porous loads, in particular:

- Pre-vacuum performance and speed and uniformity of steam penetration.
- Saturated steam temperatures and pressures reached for a certain period of time.

How to run the test:

- The test must be carried out with an empty chamber in accordance with EN 13060
- Follow the test manufacturer's guidelines
- Place the test in the center of the tray in the chamber.
- At the end of the cycle, open the sterilizer and remove the test.



WARNING! The test kit will be hot.
To correctly interpret the test, refer to the instructions provided by the test manufacturer. Open the capsule and remove the test strip.



Positive result

all areas of the indicator strip have turned dark



Negative result

Part of the indicator strip did not turn dark due to the presence of air inside the capsule.

Insufficient color change of the indicator strip fields indicates the presence of air during the test cycle due to a malfunction of the sterilizer. If the test result is incorrect, check the use-by date of the test pack, additionally check that the tubing is not clogged and obstructed, and repeat the test.

5.4 Information menu

The info menu is accessible by pressing the **Info.** button.

This level displays information about the unit type, serial number, number of processes performed and available USB memory space for saving process data, as well as the **COUNTERS** service menu - process counters for filter changes. It is also possible to change the date and time. To set the date or time touch the digits on the display. When a certain field is selected, it starts flashing and the arrows for changing the value up or down are displayed. This is how to set the date and time correctly. Pressing the number again confirms it and you can move on to changing the settings of the next parameter. In the same way, you can select the language by clicking on its abbreviation.

The button labeled **B** turns off and on the blue backlight in the depth of the screen.

Clicking the **LED** button launches the backlight control menu on the sides of the device.

Clicking a button button turns off the button sounds.

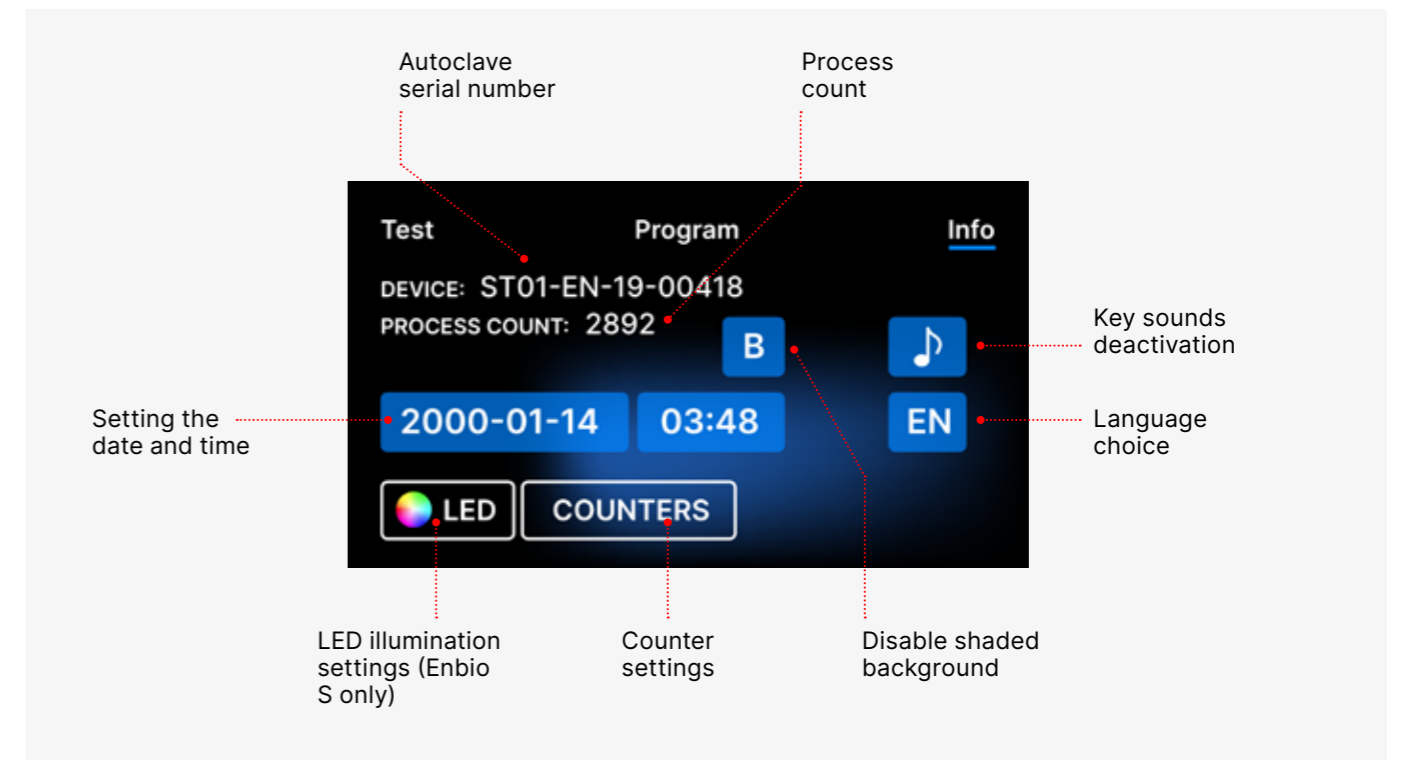

5.4.1 LED lighting

LED lighting has two modes:

- Free mode, where the user (by moving the sliders) freely sets the colors, intensity and brightness of the light to their preference.
- Continuous mode that indicates the stages of the entire sterilization process with colors LED lighting is only available in ENBIO S.

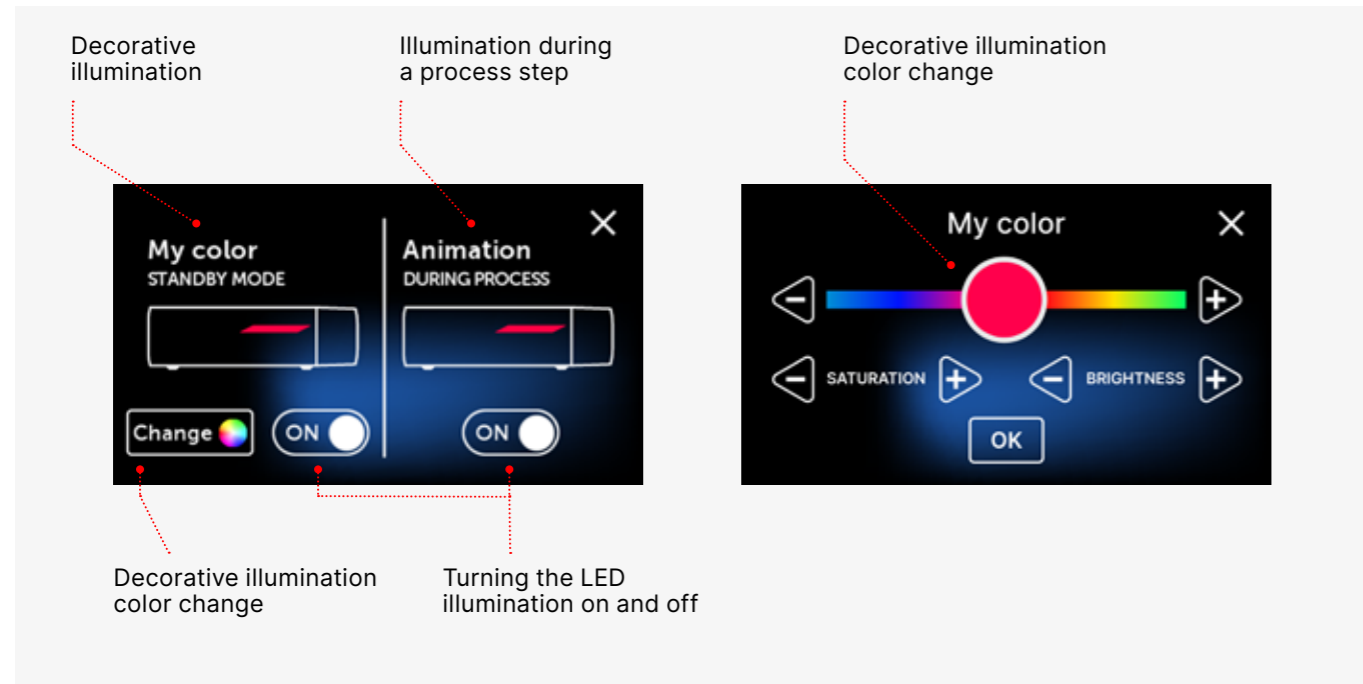

5.4.2 Counters

Enbio S and Enbio PRO sterilizers record the number of processes performed. This lets you know when you need to replace consumable parts and when a service inspection is due. ENBIO sterilizers count down to the required overhaul 12 months or 1500 processes from the time the first process was performed, whichever occurs first.

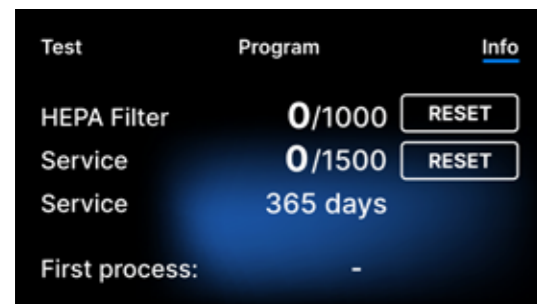

Counter section with the counters reset to zero. The number of processes performed is on the left, while on the right is the number at which the component should be replaced or a service inspection should be performed. After replacing the filter, the user can reset the values by pressing the RESET button. The value for the service check can only be reset by an authorized service technician.



During the first process (Vacuum, Helix, FAST, 134, 121), the unit will record the current date as the date of the first process (bottom line on the counter screen). The device will count processes and days since the first startup.

If the process count exceeds 1450, the device will inform the operator or user of this via a warning screen and display this value on the counter screen:

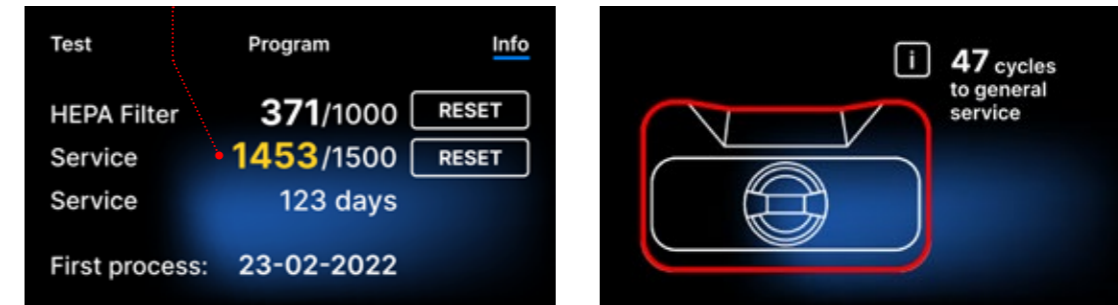

If the process number in exceeds 1500, the device informs the operator or user to perform a mandatory periodical service.



20 days before the service due date, the device will inform the operator or user of this via a warning screen and display this value on the counter screen:

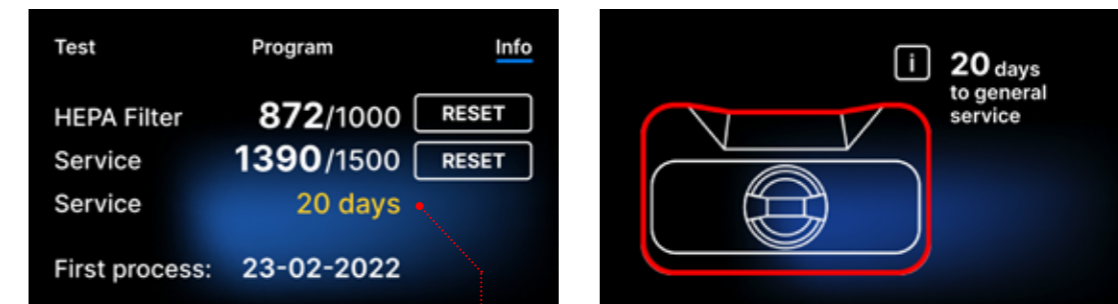

After 12 months of the first process, the device will inform the operator or user about the necessity to perform the service.

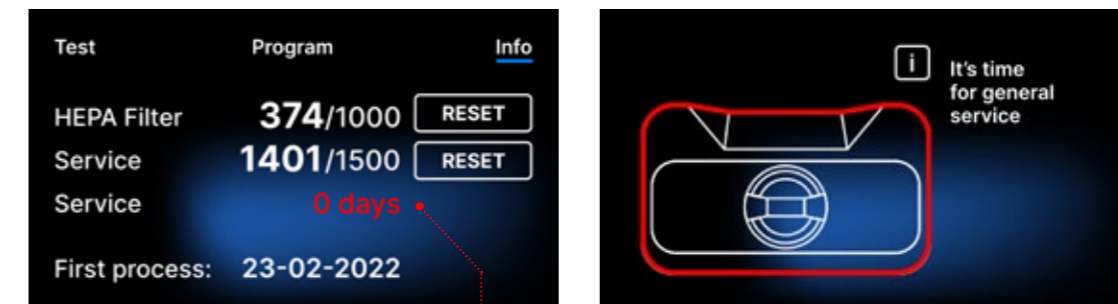

The counter can only be reset by Enbio or an authorized external service by selecting the RESET button on the counter screen and entering a unique service code.

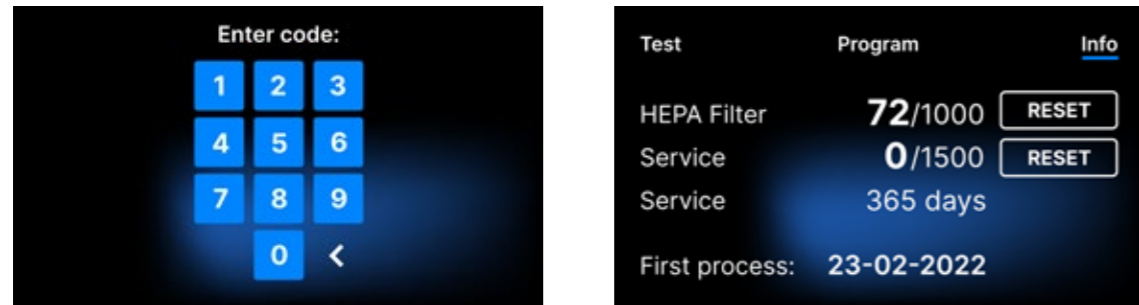

Displaying the counter values in yellow or red does not block the operation of the unit. However, exceeding the required replacement time may have a significant impact on the operation of the unit and the sterility of the load. For replacement of individual components, please contact the manufacturer or supplier.

No.	Name	Replacement frequency (cycles)	Yellow Early replacement call (cycles)	Red Latest replacement after (cycles)
1	HEPA filter	1000	980	1000

5.5 Restart

The restart of the process is forced when the user stops the process by pressing the STOP field, in the case of a power outage or an error during the process, for example lack of supply water.

If the STOP field is selected, the following messages are displayed alternately:

- the user has stopped the process
- equalizing the pressure in the working chamber
- process is incorrect, which means that the load is not sterile.



When the pressure in the working chamber is equalized, the following messages appear alternately on the display. Now you can open the device freely. After opening the chamber, the screen appears.



By selecting the field, we can return to the welcome screen. In the event of an error, we must additionally enter the 4-digit security code 0000. Entering this code is tantamount to the operator's declaration that he is aware that the sterilization process has not been carried out properly and that the batch is non-sterile.

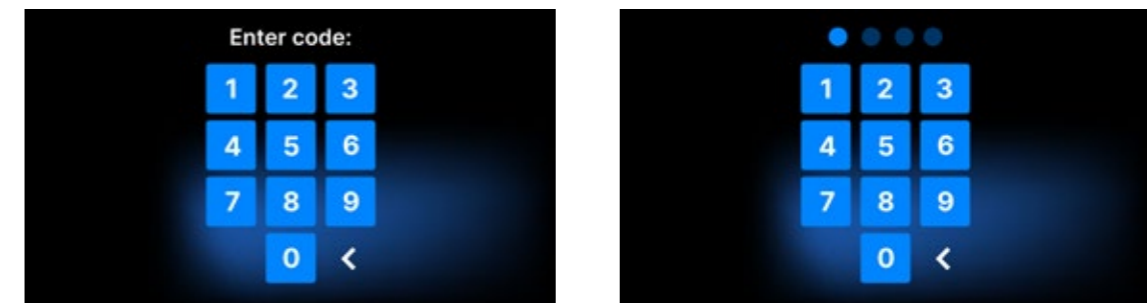

If an incorrect code is entered, a message will appear on the display.

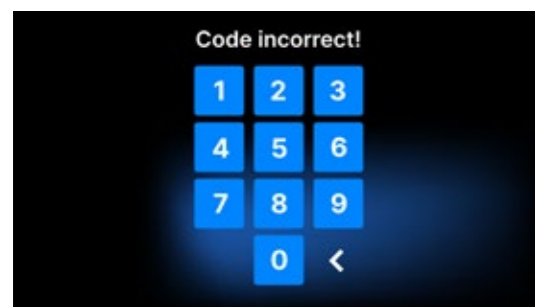

Enter the code again. The arrow enables erasing incorrectly entered digits. After entering the correct code, a welcome screen will appear on the display of the device.

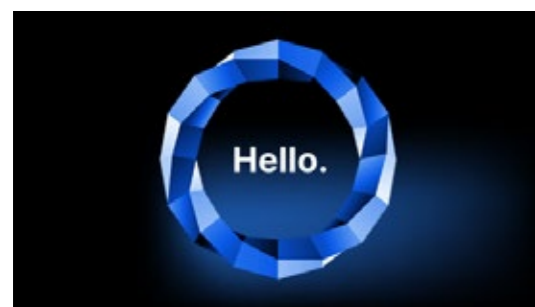

6. Service inspections

In order to ensure the correct operation of the device, the user is obliged to perform its service inspections according to the following frequency - once a year or every 1,500 processes - whichever comes first. The device has a system calendar and a process counter, so it will inform the user about the upcoming check. The service inspection should only be performed by a service centre authorised by Enbio. Failure to carry out the service inspection during the warranty period (see the document "Warranty Terms" on a USB stick supplied with an autoclave) will result in loss of warranty for the device. A list of authorised service centres can be found on the manufacturer's website www.enbio.com

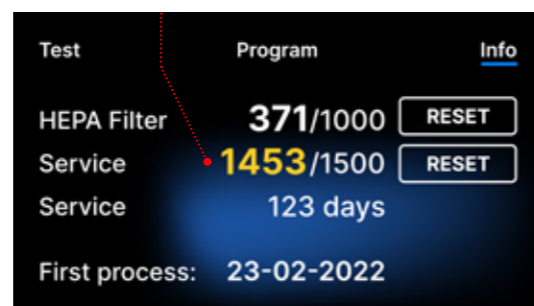
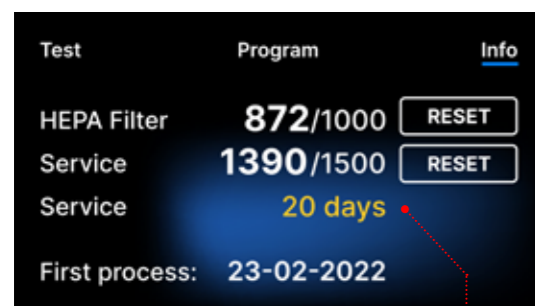

7. Device maintenance

In order to ensure the correct operation of the device, the user is obliged to perform the following maintenance actions.

Cleaning the tray

Keeping the tray clean helps to ensure proper operation of the appliance. The tray and its technical condition are a good indicator of using the correct water. A stony, brown tray indicates the use of poor quality water. It is recommended to clean the inside of the tray on a weekly basis with a mild detergent that does not add chlorine and does not react with aluminum. After cleaning, the tray requires thorough rinsing with water. In order to clean the tray properly, it should be removed from the front of the device.



Enbio S

Lift the tray up gently and pull away from the front face. The mounting pins have notches into which the drawer fits. Before reinstalling the tray into the unit, drain the tray and slide it over the front face pins and press down gently to lock.



Enbio PRO

Unscrew the 3 screws securing the tray to the front face. Remove the tray from the autoclave. Dry the tray before putting it back into the device.

Cleaning the process chamber

Keeping the chamber clean helps to ensure proper operation of the device. It is recommended to clean the inside of the process chamber once a week with a mild detergent without the addition of chlorine. After cleaning, the chamber should be wiped dry with a soft cloth. Cleaning should be performed on a cold chamber.

Cleaning of external surfaces

Cleaning the external parts of the device should be done with a soft cloth moistened with water and a mild detergent (no chlorine added and not reacting with plastics, varnish coatings, aluminum). Strong detergents should not be used. The use of mild detergents to maintain the device does not affect the risk of toxic components coming into contact with device components.

Cleaning the gasket

It is recommended to clean the gasket each time after 100 processes. Use warm, clean water and microfiber to clean the gasket (microfiber with silver particles is allowed). Blunt and sharp cleaning tools are not allowed. Cleaning with chemicals is not allowed. Carry out cleaning on a cooled down device, after opening the drawer. Be careful not to bend the drawer. After cleaning, leave the device open until the gasket is dry. During this time, protect the device against damage.

Replacement of consumables

The sterilizer is equipped with a high performance sterilization system. A message on the screen informs the user when each component should be replaced. If the sterilizer is in regular operation, alternating replacement screens will appear after the welcome screen has been pressed. The replacement screens are described in detail in section "9. Warning Messages and Error Codes".

Cleaning the water container

In order to ensure the correct parameters of the water supplying the device, it is recommended to check the water tank at least quarterly. If contamination is found, the tank should be emptied, cleaned and refilled with new water.



In order to ensure an efficient sterilization process and the correct functioning of the device, it is recommended to replace consumables in a timely manner.

Replacing the Enbio Magic Filter

The filter should be replaced with a new one once every 6 months or sooner when the resin has completely discolored to an amber color. Failure to do so may disrupt the sterilization process and will void the sterilizer warranty. Dispose of the used filter according to local guidelines. The filter and all its parts are not recyclable.



7.1 Consumables

The table below contains items subject to periodic replacement and items subject to natural wear. Spare parts must be ordered directly from the manufacturer. The use of other spare parts voids the warranty and does not guarantee the correct functioning of the device.

Name	Part no
HEPA filter Enbio S / PRO	1-8-27720A5
Enbio S front kit with gasket	1-8-14672D2
Enbio S tray	1-8-14738B2
Enbio PRO front kit with gasket	1-8-12433A45
Tray set 3 pieces Enbio PRO	1-8-1097954A1
Wastewater set (plug + red hose 1.5 m)	1-8-42988A1
Feed water set (plug + blue hose 1.5 m)	1-8-42992A1
Enbio Magic Filter	1-8-1116687A5

To ensure proper functioning of the Enbio S / Enbio PRO steriliser, it is recommended that the wearing parts be replaced according to the schedule below. And periodic inspection of the individual components of the sterilizer in accordance with the following guidelines.

Name	Replacement frequency
HEPA bacteriological filter	Every 1000 cycles or every 12 months
Connection / drain hose	If damage is observed or once a year
Plugs for water / condensate containers	If damage is observed
Front drawer with seal	Replacement at mandatory service after 1500 cycles/365 days
Enbio Magic Filter	Replace the filter once every 6 months or sooner when the resin has completely discolored to an amber color

Element to be controlled	Frequency of inspections
Front gasket	weekly or in the event of incorrect operation - performed by the user
Bacteriological filter	every week - performed by the user
Connection / drain hose	weekly or in the event of incorrect operation - performed by the user
Container stoppers	weekly - performed by the user
Enbio Magic Filter	weekly - performed by the user

8. Data archiving

The course of each performed sterilization is automatically saved on a data carrier (USB stick).

- The memory slot is located on the rear panel of the device.
- It is recommended to periodically archive the data on another medium e.g. computer, laptop.
- The USB flash drive should not be removed from the slot during the process.

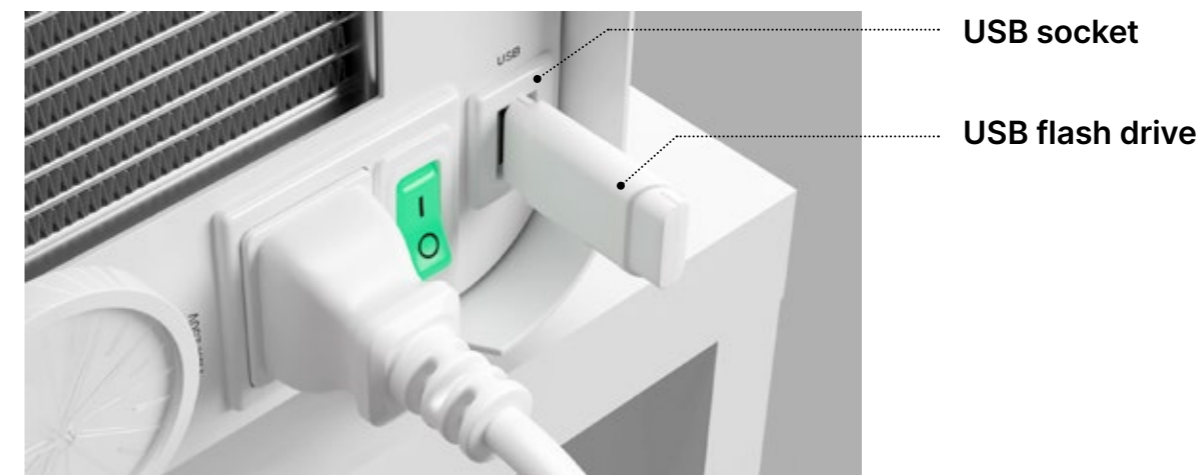

9. Enbio Data Viewer software

EnbioDataViewer software allows you to view and archive sterilization programs on your computer and print them out.

Minimum hardware requirements to install the software:

- Operating system - Windows min. Windows 7 or higher
- Free disk space - min. 100 MB
- Minimum processor requirements - min. 1 GHz
- Minimum operating memory - min. 512 MB Ram
- Screen resolution - min. 1200x720 or higher

9.1 Installing the software



The software is delivered with the device and is on a portable drive - USB flash drive or the latest version can be downloaded from the manufacturer's website <http://enbio.com/service/>

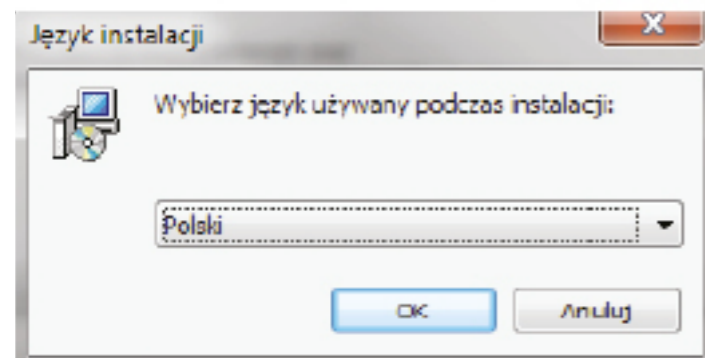

To install the software, double click on the software installation file. After this operation an installation window will be displayed regarding language selection.

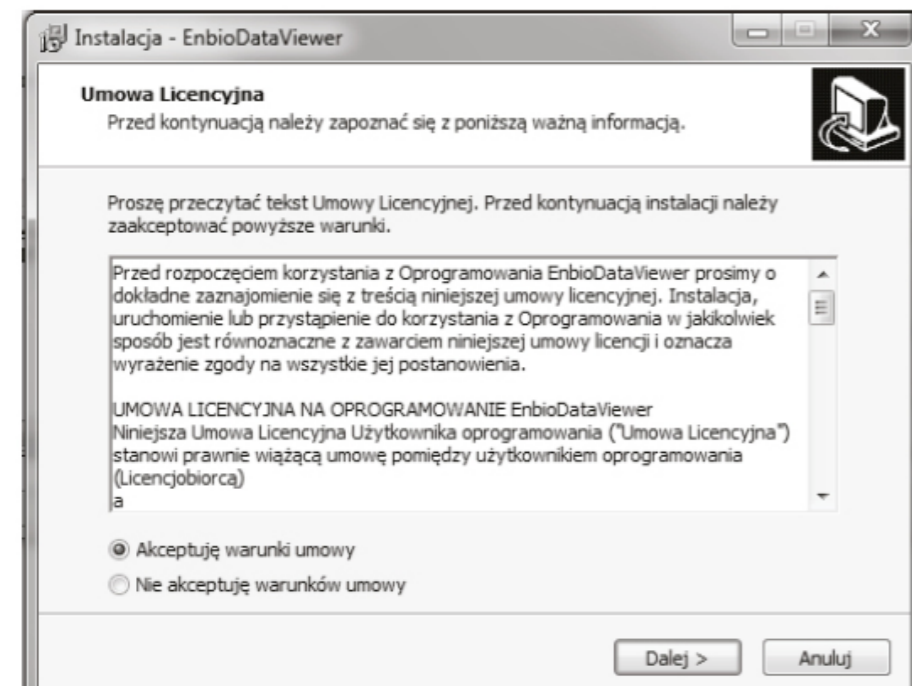

After confirming, you must accept the license terms for the software being installed.

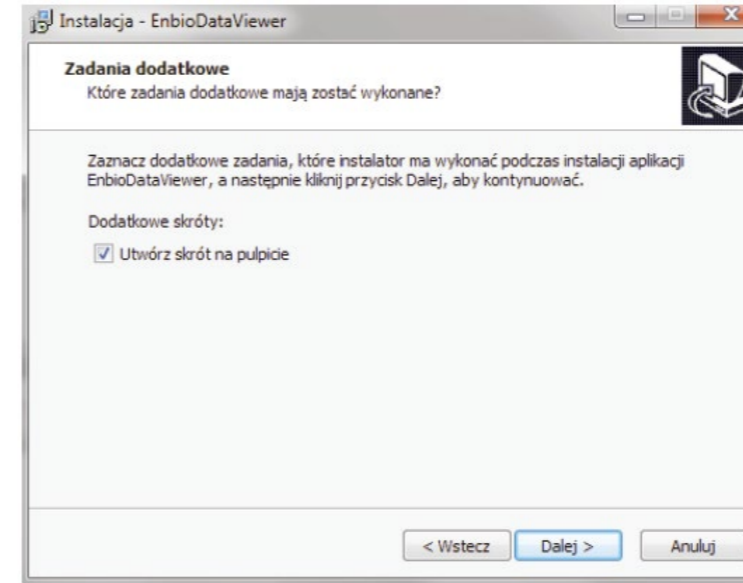

You will then be prompted to place a shortcut to the software on your computer desktop.

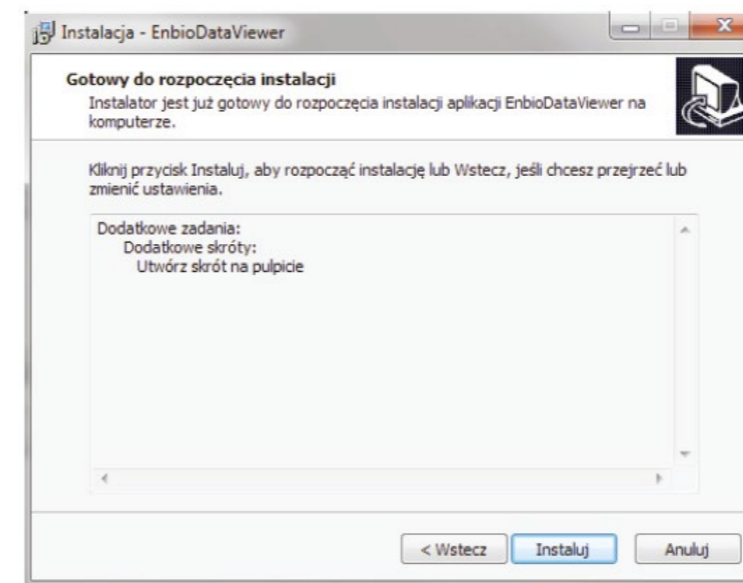

After clicking "Next>", the folder where the program should be installed is selected.

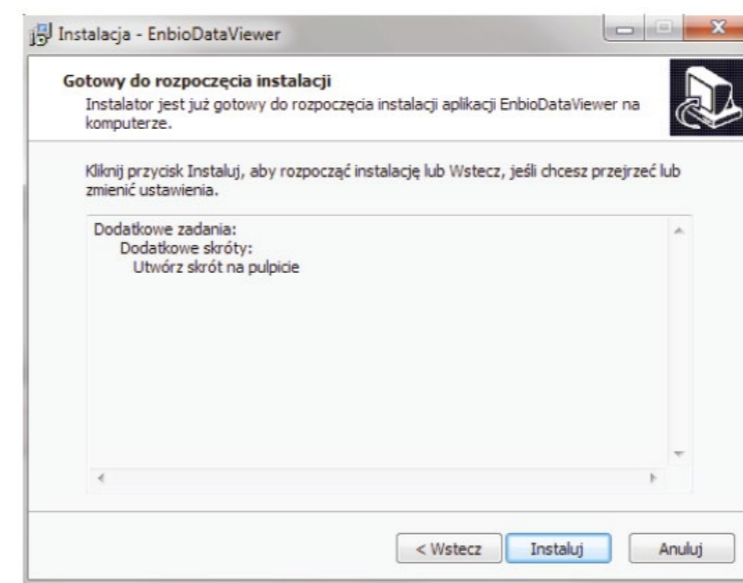

After making your selection, click "Next". By clicking the Install button, the Enbio Data Viewer software will be installed.

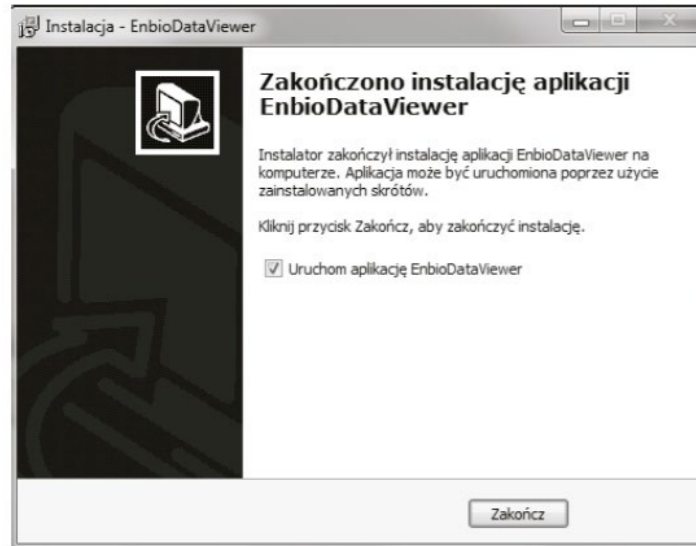

After the installation, the following message appears.

We can now run the software or finish the installation without running the software by clicking the Finish button.

If you select the option with immediate start, the main program window is displayed.



9.2 Program structure and main functionalities

The main window consists of three main areas

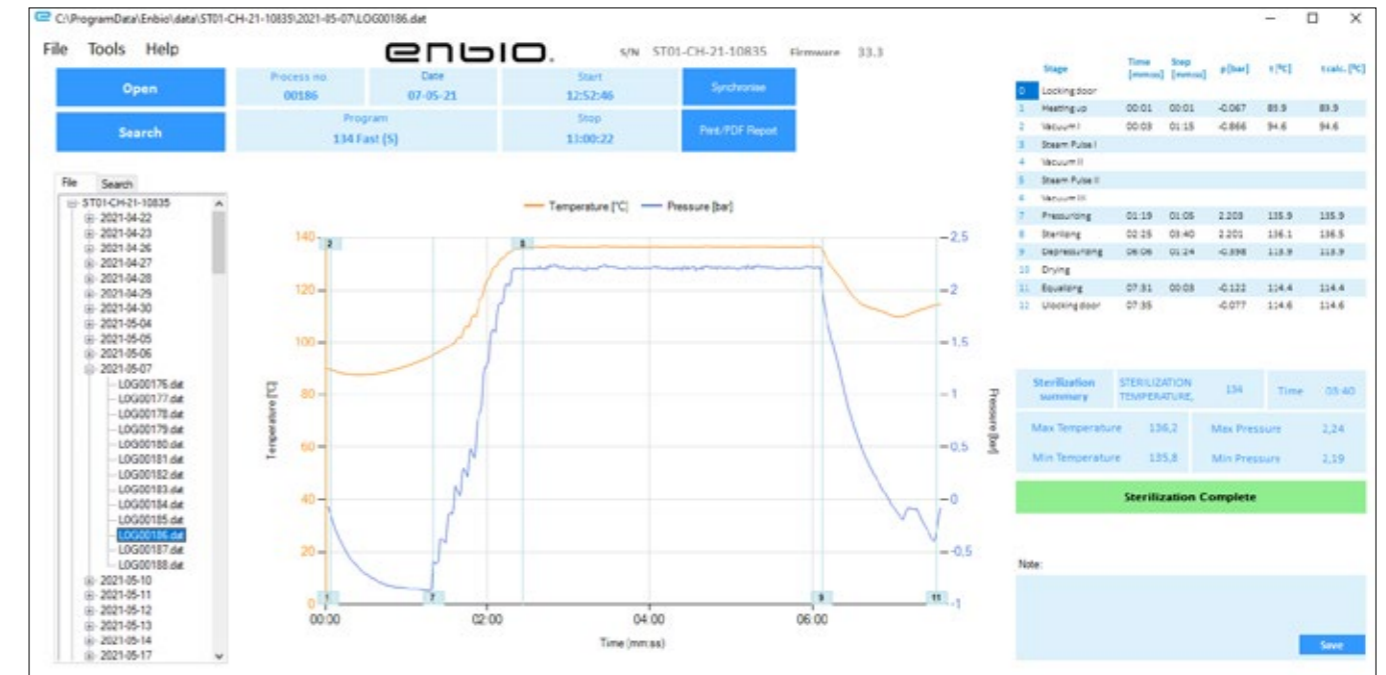

Tree of all processes that have been synchronized with the flash drive - have been sorted by execution dates

Temperature and pressure graph with main autoclave and process data (date and number).

Data on the duration and achieved parameters of each process step.

The most important sterilization parameters.

Possibility to save notes for each process.

The function buttons, eg "PDF report", which will enable printing the protocol from the process, are marked in dark blue.

Drop-down menu:

By clicking on the File window, we have access to the following options:

- loading the saved process flow from a flash drive or from another location
- print a saved process
- create a report to a PDF file
- exporting data to a file in order to send a package with data to the manufacturer in case of problems
- data export to CSV format
- closing the program



By clicking on the Tools window, we have access to the following options:

- synchronization of all files with saved processes after selecting memory location on pendrive (this process, depending on the number of sterilizations and tests performed can take up to several seconds)
- searching for any saved process from the database
- adding your own logo to PDF reports



By clicking on the drop-down menu in Help, we have access to the following options: about the program and its version

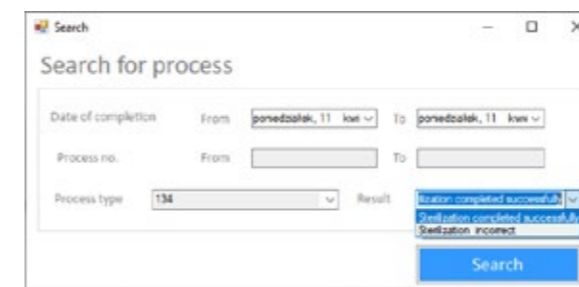

Search

The program allows you to search for processes by:

- date range
- process number
- process type
- process outcome (success/fail)



PDF report

The program allows you to generate a report on each process performed by the autoclave. It contains all the necessary process data and the sterilization result.

10. Warning messages and error codes

In the event of a device malfunction, the display shows the relevant information, warning and error codes.

10.1 Warning messages

The warning messages refer to the replacement of individual consumables. The item to be replaced is highlighted in red, and the screens are displayed alternately.

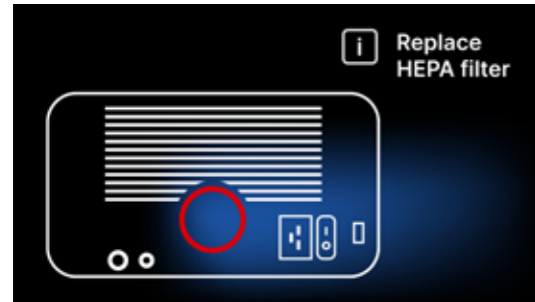

Filter replacement screen

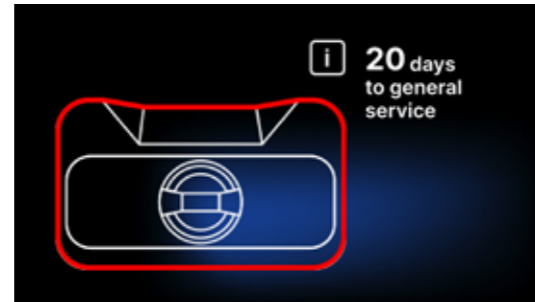

Mandatory inspection screen

10.2 Information messages

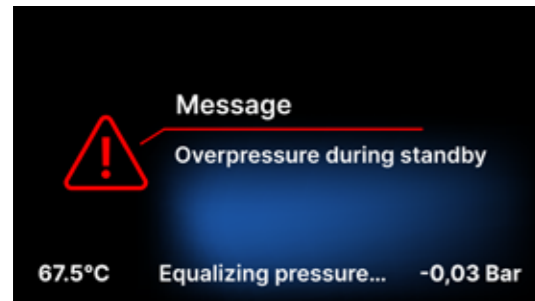

Screen about overpressure or underpressure resulting from the natural processes of cooling the chamber. It can occur immediately after starting the machine.



Message resulting from interruption of the process after the sterilization stage - during drying.

10.3 Error codes

The table below contains error codes that may appear when working with the ENBIO S / ENBIO PRO sterilizer

No	Error code	Description	Recommendations
1	"Chamber over temperature"	Maximum chamber temperature exceeded	Contact with the service
2	"Steam gen. Over temperature"	Steam generator temperature too high	<ul style="list-style-type: none"> Too high weight of sterilized instruments - repeat the process with less instruments (max. 0.5 kg S, 0.8 kg PRO) Contact with the service
3	"Process over temperature"	Process temperature too high	Contact with the service
4	"Overpressure error"	Pressure error	Contact with the service
5	"Sterilization pressure too low"	Drying pressure too low	<ul style="list-style-type: none"> Check that there is water in the bottle with the blue hose Correct the position of the blue hose so that the end is completely submerged in water. Add a sinker to eliminate the problem in the future Check that the water supply hose (blue) is not damaged (After correcting the position / replacing the hose or refilling with water, restart the machine) Contact with the service
6	"Sterilization temp. Too low"	Sterilization temperature too low	<ul style="list-style-type: none"> Check the water level in the bottle with the blue hose Check that the red tube is not pointing up along its entire length, creating the so-called air trap Contact with the service
7	"Too high pressure during drying"	Drying pressure too high	<ul style="list-style-type: none"> Make sure the red drain hose is not immersed in water. The hose must not be kinked, the liquid must flow down by gravity Check that the weight of the sterilized instruments is not too high Contact with the service
8	"Too many steam pulses / no water"	Too many steam pulses. No feed water.	<ul style="list-style-type: none"> Check the water connection to the "water in" connector Check the distilled water level in the feed water tank (blue plug) Check that the weight of the load does not exceed the allowable weight. Contact with the service
9	"Drainage error"	Clogged drain	<ul style="list-style-type: none"> Check the level of the wastewater and the connection of the hoses Check the level of the used water in the bottle with the red cap. If the bottle is full, discard the used water Check that the red hose is not kinked and that it is pointing downwards along its entire length Check that there is no debris in the outlet opening (inside the chamber) Contact with the service

10	"Chamber heating error"	Chamber heating error	<ul style="list-style-type: none"> Mains voltage too low - consult an electrician for the location where the autoclave is to be installed Contact with the service
11	"Steam generator heating error"	Steam generator error	<ul style="list-style-type: none"> Repeat the process Contact with the service
12	"Prevacuum fail / check outlet"	Vacuum pump / drain fault	<ul style="list-style-type: none"> Check the level of used water in the bottle with the red cap and pour out the excess Check that the red hose is not submerged or kinked Check that the autoclave setting provides free airflow for cooling the unit The red hose must point downwards along its entire length, no section may point upwards Clean the chamber door seal Contact with the service
13	"Power failure"	Momentary voltage loss during operation	<ul style="list-style-type: none"> Restart the device and make sure it is properly plugged into the outlet Consult an electrician competent for the site where the autoclave is installed to check the installation
14	"Pressure during standby"	Overpressure while waiting	<ul style="list-style-type: none"> Restart your device Contact with the service
15	"Locking door error"	Door lock error	Contact with the service
16	"Unlocking door error"	Door unlock error	<ul style="list-style-type: none"> Turn off the autoclave and turn it on again, start the process and stop it after a few seconds. There must be no overpressure in the chamber, i.e. the following information must be displayed: "READY / Chamber is safe to open" Contact with the service
17	"Valve V3 / HEPA filter error"	V3 valve / HEPA filter error	<ul style="list-style-type: none"> Replace the HEPA filter Contact with the service
18	"Pressure sensor error"	Pressure sensor error	Contact with the service
19	"USB disc error / Change disc"	Writing error on pendrive - damage to medium	Copy the contents from your current flash drive - buy and install a new one
20	Min. Chamber temperature	Chamber temperature too low during the process	Contact with the service
21	Chamber temperature sensor failure	Chamber temperature sensor failure	Contact with the service
22	Steam gen. Temp. Sensor failure	Steam generator temperature sensor failure	Contact with the service
23	Process temp. Sensor failure	Process temperature sensor failure	Contact with the service
24	Autoclave has too low temperature	Autoclave temperature too low / temperature sensor error	<ul style="list-style-type: none"> Leave the device switched off for 3 hours at room temperature Contact with the service
31	"Internal flash error"	Internal memory error	Contact with the service

Messages

"Aborted by user"	Process interrupted by the user. Non-sterile cartridge if interrupted during or before the sterilization process.	This message appears when the user terminates the process. This does not mean that there is a malfunction. Start a new process.
"Vacuum test failed"	Vacuum test error	Contact with the service
"No USB memory"	No USB memory stick	Check the USB port and mount the memory. Contact with the service.
"Equalizing pressure"	Pressure when stationary. Equalization of pressure to atmospheric.	<ul style="list-style-type: none"> The message occurs in certain cases as a result of natural processes. If the message appears frequently, contact the service center.
"Overpressure during standby"	Hypertension in standby mode	The reason for this error is that the hot sterilizer is left with the chamber closed (e.g. overnight). As the sterilizer cools down a vacuum is created in the chamber which causes a startup error. Wait until the device has equalized the pressure automatically - the message will disappear automatically

Here are some examples of error codes:
Alternating screens: pressure equalization, please wait.

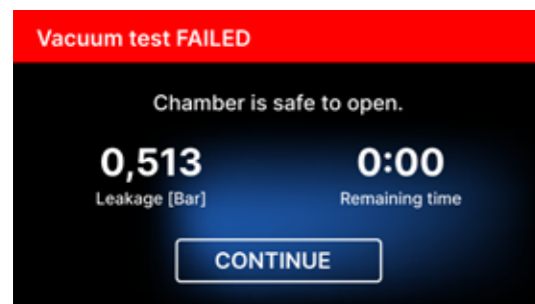

A QR code is displayed in error message screens. By scanning this code with a mobile phone with the option of reading QR codes, the user will be redirected to a website containing recommendations on the possibility of eliminating the error.



11. Complaints procedure

In order to report a problem with the device, complete the complaint form on the manufacturer's website www.enbio.com or contact the hotline. In the event of transport damage, a claim should be sent along with a bill of lading and a purchase document as well as photos documenting the damage.

If you have any questions, please contact us by e-mail at: support@enbio.com



WARNING! The complaint process will be started when the service department receives a correctly completed complaint application.

When returning the device for service, clean the chamber and the tray of the device, carry out the decontamination process and secure it properly during transport. The device should preferably be returned in its original packaging. In the absence of appropriate packaging, please contact the service or supplier.

If you need to transport the device:

- Disconnect the demineralized water and condensate hoses
- Allow the working chamber to cool.
- Use original or suitable packaging with protective inserts

Damage caused during transport to the service due to improper protection of the device is the responsibility of the sender.

12. Warranty conditions

Please refer to "Warranty conditions" document (available on USB stick supplied with the autoclave).

13. Technical data

Device parameters	Enbio S	Enbio PRO
Power supply	220-240V AC 50 / 60Hz	220-240V AC 50 / 60Hz
Installed power	2.25 kW max.	3.25 kW max.
Maximum current consumption	10 A	15 A
Working pressure	2,1 bar	2,1 bar
Maximum pressure	2,3 bar max	2,3 bar max
Maximum process temperature	137°C	138°C
Process chamber volume	2,7 l	5,3 l
Weight	15 kg	20 kg
Process chamber dimensions (LxWxH)	292 × 192 × 45 mm	300 × 200 × 90 mm
External dimensions of the device (LxWxH)	561 × 252 × 162 mm	561 × 270 × 202 mm
Degree of protection	IP20	IP20
Noise level	38dB(A)	40dB(A)
Archiving process data	Pendrive	Pendrive

Environmental conditions

Working temperature range	from + 5°C to + 25°C
Relative humidity	0-90%
Storage temperature range	-20°C to + 60°C
Relative humidity	0-90%
Ambient pressure range	900-1100 hPa



Test connector - for use by authorized service only. If found to be used by the user, it will void the warranty.

Rating plate located on the bottom of the device.

Enbio S

enbio® REF Enbio S™ TYPE Class B	
Manufacturer Enbio Group AG Eichengasse 3 4702 Oensingen Switzerland	 RoHS PATENTED
EC REP Enbio Technology sp. z o.o. ul. Sportowa 8C 81-300 Gdynia, Poland	Power supply 220-240V AC 10A 50/60Hz 2,25kW max

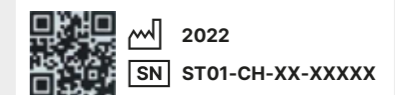

Enbio PRO

enbio® REF Enbio PRO™ TYPE Class B	
Manufacturer Enbio Group AG Eichengasse 3 4702 Oensingen Switzerland	 RoHS PATENTED
EC REP Enbio Technology sp. z o.o. ul. Sportowa 8C 81-300 Gdynia, Poland	Power supply 220-240V AC 15A 50/60Hz 3,25kW max

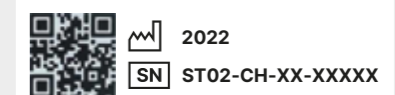

Enbio Group AG
 Eichengasse 3
 4702 Oensingen
 Switzerland

14. EC declaration of conformity



EC Declaration of Conformity

Manufacturer **ENBIO GROUP AG, Eichengasse 3 Street, 4702 Oensingen, Switzerland,**

having: Enbio Technology Sp. z o. o., Sportowa 8C Street, 81-300 Gdynia, Poland, as an European Authorized Representative,

declares with sole responsibility, that medical devices: **STEAM STERILIZERS**, models:

- **Enbio S**
- **Enbio PRO**
- **Enbio XS**

complies with provisions of Council Directive 93/42/EEC of 14 June 1993 concerning medical devices (as amended). The device has been classified in Class IIb in accordance with rule 15 of Annex IX of the above mentioned Directive.

Conformity assessment has been carried out in accordance with Annex II without point 4 of the above Regulations.

The conformity assessment has been conducted by the Notified Body No. 2274

TUV Nord Polska Sp. z o.o.

Mickiewicza 29 Street

40-085 Katowice

Poland



Sebastian Magrian

Oensingen

26.04.2021

Managing Director

President of the Board

Version: 06_04.2021